

Ultrasonic Flowmeter Instruction Manual

Model: SL1188



SITELab

Reversion: 8.0

Date: May 2008

Update	Reversion	
Record	Date	

Notice

Thank you for choosing the SL1188 Ultrasonic Flowmeter with SLSI CMOS and low-voltage wide-pulse sending technology.

This instruction manual contains important information. Please read carefully before the operation of the flowmeter.

**Warning**



May cause injury

**Attention**

May damage the flowmeter

Product Components

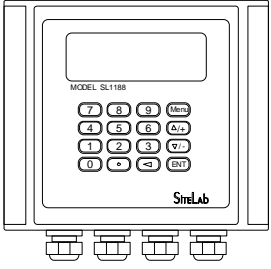
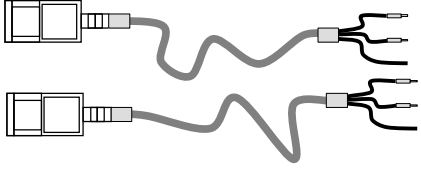
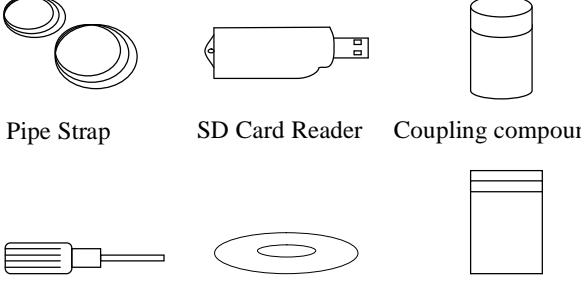
Inspection should be made before installing the Flowmeter. Check to see if the spare parts are in accordance with the packing list. Make sure that there is no damage to the enclosure due to a loose screw or loose wire, or other damage that may have occurred during transportation. Any questions, please contact your representative as soon as possible.

Transmitter	Transducer
	
Accessory	Document
 <p>Pipe Strap SD Card Reader Coupling compound</p> <p>Screw Driver Software Screws and plastic bushings</p>	 <ol style="list-style-type: none"> 1. Instruction Manual 2. Packing List 3. Certified 3-Point Factory Calibration 4. Position drawing 5. Application Worksheet

Content

- 1. Transmitter Installation and Connect4
 - 1.1. Inspection prior to Transmitter Installation4
 - 1.2. Power Supply Connecting4
 - 1.2.1. Direct Mount Method4
 - 1.2.2. Connecting the Wiring4
 - 1.3. Powering on4
 - 1.4. Keypad Functions4
 - 1.5. Keypad Operation4
 - 1.6. Flowmeter Window Descriptions4
- 2. Pipe Parameter Entry Shortcuts.....4
- 3. Measurement Site Selection.....4
- 4. Transducer Installation.....4
 - 4.1. Installing the transducers4
 - 4.1.1. Transducer spacing4
 - 4.1.2. Transducer Mounting Methods.....4
 - 4.1.3. V Method4
 - 4.1.4. Z Method4
 - 4.1.5. N Method (not commonly used).....4
 - 4.1.6. W Method (very rarely used).....4
 - 4.2. Transducer Mounting Inspection4
 - 4.2.1. Signal Strength.....4
 - 4.2.2. Signal Quality (Q value).....4
 - 4.2.3. Total Time and Delta Time4
 - 4.2.4. Transit Time Ratio4
 - Warnings4
- 5. Operating Instructions.....4
 - 5.1. System Normal Identification.....4
 - 5.2. Zero Set Calibration.....4
 - 5.3. Scale Factor4
 - 5.4. System Lock (Unlock).....4
 - 5.5. 4~20mA Current Loop Verification4
 - 5.6. Frequency Output4
 - 5.7. Totalizer Pulse Output4
 - 5.8. Alarm Programming4
 - 5.9. Batch Controller4



- 5.10. Analog Output Calibration4
- 5.11. Use of the memory card.....4
 - 5.11.1. Specifications.....4
 - 5.11.2. Install or Remove while the meter is powered ON.....4
 - 5.11.3. Reading the SD Data Externally4
 - 5.11.4. Reading the SD Data Internally with the Instrument powered ON4
 - 5.11.5. File converter tool.....4
- 5.12 Recover the Factory Default4
- 5.13. ESN4
- 6. Windows Display Explanations4**
 - 6.1. Windows Display Codes.....4
 - 6.2. Display explanation4
- 7. Error Diagnoses4**
 - 7.1. Table 1. Self-diagnoses and error solutions (upon power on).....4
 - 7.2. Table 2. Error codes and solutions (during operation).....4
 - 7.3. Frequently Asked Questions and Answers.....4
- 8. Product Overview4**
 - 8.1. Introduction4
 - 8.2. Features of SL1188.....4
 - 8.3. Theory of Operation4
 - 8.4. Applications.....4
 - 8.5. Specifications4
- 9. Appendix 1 - Flow Application Data.....4**
 - 9.1. Sound Velocity and Viscosity for Fluids Commonly Used.....4
 - 9.2. Sound Velocity for Various Materials Commonly Used.....4
 - 9.3. Sound Velocity in Water (1 atm) at different temperatures.....4
- 10. Appendix 2 - Calorimeter4**
 - 10.1. Calorimeter Function4
 - 10.2. Wiring.....4
 - 10.3. Calorimetry Method4
 - 10.4. Set Temperature Value Range.....4
- 11. Appendix 3 - Wetted Transducer4**
 - 11.1. Overview4
 - 11.2. Measurement Point Selection4
 - 11.3. Determining Transducer Spacing & Transducer Installation.....4
 - 11.4. Transducer Mounting Methods.....4

11.4.1. Z Mounting Method.....4
11.4.2. V Mounting Method4
11.4.3. W Mounting Method4

12. Appendix4 - Serial Interface Network Use and Communications Protocol4

12.1. Overview4
12.2. Serial port definitions4
12.3. Direct connection via RS232 to the host device4
12.4. Communication protocol and the use4
 12.4.1. Basic commands4
 12.4.2. Function prefix and function sign.....4
12.5. Key Code4

Update Information:



1. Transmitter Installation and Connect

1.1. Inspection prior to Transmitter Installation

You will find a “Position Drawing” in the packing. Please use it as a template in the place that you are going to install the flowmeter. Then drill 4 installation holes at the screw position shown on the drawing with the 5.5mm aiguille. (right picture)

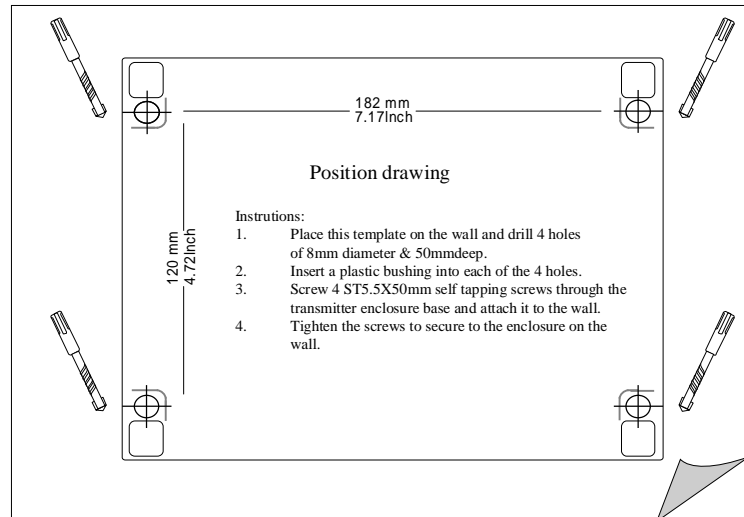

Take out the enclosed screws and plastic bushings. Insert the plastic bushings into the installing holes. Then open the two aluminum pieces on the two sides of the top cover. Put the flowmeter into the position and screw it in. (right picture)

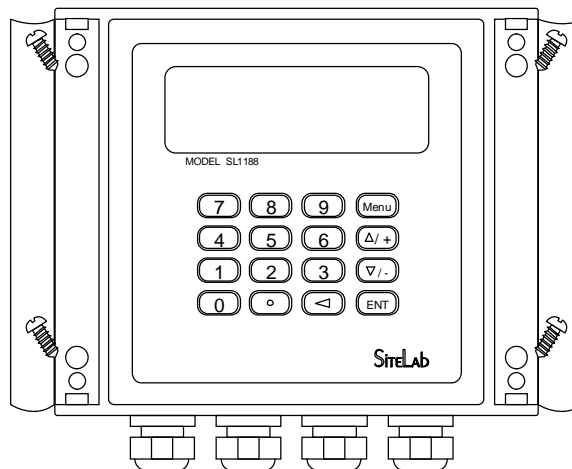

Attention

When installing please make sure that the installing face can afford the flowmeter to avoid falling off. And make sure the installing face is dry.

1.2. Power Supply Connecting

1.2.1. Direct Mount Method

Customers should pay special attention to specify the desired power supply when placing an order. Factory standard power supply is 90~245 VAC.

Observe the following precautions for installation procedures outlined in this chapter:

Ensure that power connections are made in accordance with the indications shown on the connection terminals. Transmitters can be powered by two different power supplies: 90~245VAC or 10-36VDC

1.2.2. Connecting the Wiring

Once the electronics enclosure has been installed, the flowmeter wiring can be connected. Open the case, terminals 11, 12, 13 can be found at the left lower side. Connect to AC power. Terminal 11 is grounded (earth) while connecting.

As per wiring diagram to connect 4-20mA Output (terminals 16, 17), Downstream transducer (terminals 18, 19, 20), Upstream transducer (terminals 21, 22, 23) .Analog Input (terminals 24, 25, 26), OCT Output (terminals 27, 28) and Relay Output(terminals 29, 30).

For double-shielded transducer cable: "-" on the black wire, "+" on the red wire and "shield" on the shield.

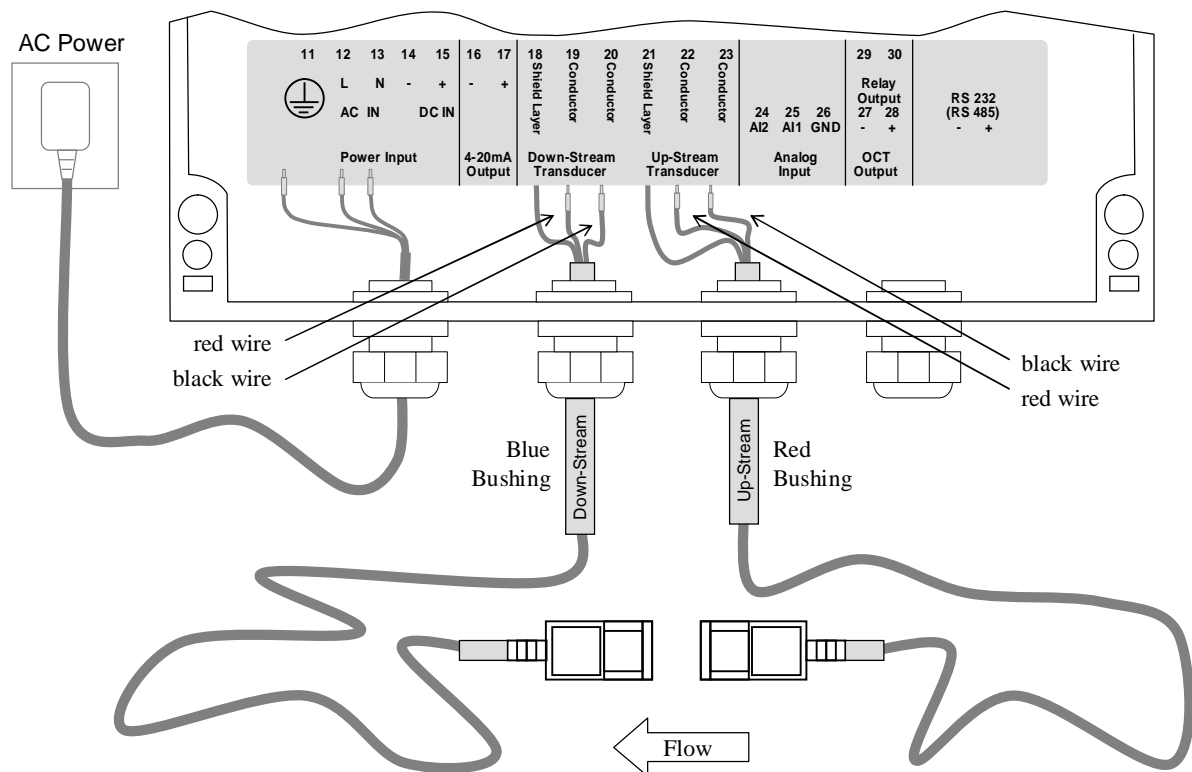

Warning

Wire with power off.

Use either AC or DC power supply. Do not connect them both at the same time.

1.3. Powering on

As soon as the Flowmeter is switched on, the self-diagnosis program will start to run. If any error is detected, an error code will display on the screen (Refer - Error Diagnoses). After that, the system will run automatically according to the last input parameters.

If the installation is accomplished when system is switched on, gain adjustment can be monitored in Window M01. After S1, S2, S3, S4 are displayed on the upper left corner of the screen, the system will activate the normal measurement condition automatically. It is indicated by code “*R” on the upper left corner of the screen.

The system will default to the last window settings and automatically display them at next power on.

1.4. Keypad Functions

Follow these guidelines when using the Flowmeter keypad (Refer to Keypad Figure):

- ⓪ ~ ⑨ And ①⓪ input numbers.
- ⬅ Backspace or delete characters to the left.
- ⬆ And ⬇ Return to the last menu or to open the next menu. acts as “+” and “-” functions when entering numbers.
- Ⓜ Select a menu. Press this key first, input two menu numbers and then enter the selected menu. For example, To Input a pipe outside diameter, press Ⓜ①① keys, where “11” is the window ID to display the parameter for pipe outside diameter.

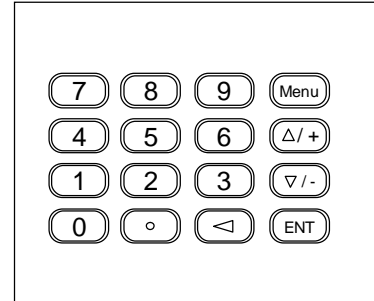

1.5. Keypad Operation

With all of the parameters entered, the instrument setup and measurement displays are subdivided or consolidated into more than 100 independent windows. The operator can input parameters, modify settings or display measurement results by “visiting” a specific window. These window are arranged by 2-digit serial numbers (including “+” sign) from 00~99, then to +0, +1, etc. Each window serial number, or so-called window ID code, has a defined meaning. For example, Window M11 indicates the parameter input for pipe outside diameter, while Window M25 indicates the mounting spacing between the transducers, etc. (Refer – Windows Display Explanations).

The keypad shortcut to visit a specific window is to press the Ⓜ key at any time, then input the 2-digit window ID code. For example, to input or check the pipe outside diameter, just press the Ⓜ①① keys for window ID code 11.

Another method to visit a particular window is to press ⬆ ⬇ and Ⓜ keys to scroll the screen. For example, if the current window ID code is 66, press ⬆ key to enter Window M65, press the ⬆ key again to enter Window M64; then, press the ⬇ key to back Window M65, and press the ⬇ key again to enter Window M66.

Example1: To enter a pipe outside diameter of 219.234, the procedure is as follows:

Press Ⓜ①① keys to enter Window M11 (the numerical value displayed currently is a previous value). Now press Ⓜ key. The symbol “>” and the flashing cursor are displayed at the left end of the second line on the Screen. The new value can be entered then...

②①⑨Ⓜ②③④Ⓜ

Example2: If the pipe material is “Stainless Steel”, press keys Ⓜ①④ to enter Window M 14 first. Then press Ⓜ key to modify the options. Now, select the “1. Stainless Steel ” option by pressing ⬆ and ⬇ keys, and then press Ⓜ key to confirm the selection. It is possible to press the ① key to change the selection and wait until “1. Stainless Steel” is displayed on the second line of the screen. Then press the Ⓜ key to confirm.

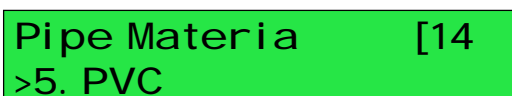
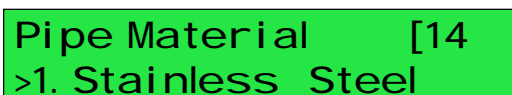

**Attention**

Generally, press **ENT** key first if operator wants to enter “modify” condition. If the “modify” is still not possible even after pressing the **ENT** key, it means that system is locked by a password. To “Unlock” it, select “Unlock” in Window M47 and enter the original password. The keypad will not respond if the keypad is locked.

1.6. Flowmeter Window Descriptions

The Flowmeter has the unique feature of windows processing for all operations.

These windows are assigned as follows:

- 00~09 Flow Totalizer Display: to display flow rate, positive total, negative total, net total, velocity, date & time, analog inputs for present flow, present operation and flow results today, etc.
 - 10~29 Initial Parameter Setup: to enter pipe outside diameter, pipe wall thickness, fluid type, transducer type, transducer mounting and spacing, etc.
 - 30~38 Flow Units Options: to select the flow unit, totalizer unit, measurement unit, turn totalizers on/off and reset totalizes, etc.
 - 40~49 Setup options: Scaling factor, network IDN (Window M46), system lock (Window M47), etc.
 - 50~89 Input and output setup: relay output setup, 4-20mA outputs, flow batch controller, LCD backlit option, date and time, low/high output frequency, alarm output, date totalizer, etc.
 - 90~95 Diagnoses: Signal strength and signal quality (Window M90), TOM/TOS*100 (Window M91), flow sound velocity (Window M92), total time and delta time (Window M93), Reynolds number and factor (Window M94), Data Interval (Window M95) etc.
 - +0~+5 Appendix: power on/off time, total working hours, on/off times and a single-accuracy function calculator.
-

**Attention**

The other windows are for hardware adjustment by the manufacturer.

2. Pipe Parameter Entry Shortcuts

For example, measuring the diameter of DN200, measuring medium is water, Material is carbon steel, No Liner, can be operated as follows:

Step1. Pipe outside diameter:

Press keys to enter Window M11, and enter the pipe outside diameter, and then press the key.

Pipe Outer Diameter
200 mm

Step2. Pipe wall thickness

Press the key to enter Window M12, pipe wall thickness, and press the key.

Pipe Wall Thickness
6 mm

Step3. Pipe material

Press the key to enter Window M14, press the key, move the or key to select pipe material, and press the key.

Pipe Material [14
0. Carbon Steel

Step4. Liner material parameters

(including thickness and sound velocity, if needed)

Press the key to enter Window M16, press the key, move the or key to select liner material, and press the key.

Linner Material [16
0. None, No Liner

Step5. Fluid type

Press the key to enter Window M20, press the key, move the or key to select fluid type, press the key.

Fluid Type [20
0. Water

Step6. Transducer type

(The transmitter is available for various transducer types)

Press the key to enter Window M23, press the key, move the or key to select transducer type, and press the key.

Transducer Type [23
0. Standard

Step7. Transducer mounting methods

Press the key to enter Window M24, press the key, move the or key to select transducer-mounting method, and press the key.

Transducer Mounting
O. V

Step8. Adjust Transducer spacing

Press the key to enter Window M25, accurately install the transducer according to the displayed transducer mounting spacing and the selected mounting method (Refer to Installing the Transducers in this chapter).

Transducer Spacing
159.86 mm

Step9. Display measurement result

Press the keys to enter Window M01 to display measurement result.

Flow 0.1129m³/h * R
Vel 1.0415m/s

3. Measurement Site Selection

When selecting a measurement site, it is important to select an area where the fluid flow profile is fully developed to guarantee a highly accurate measurement. Use the following guidelines when to select a proper measurement installation site:

Choose a section of pipe, which is always full of liquid, such as a vertical pipe with flow in the upward direction or a full horizontal pipe.

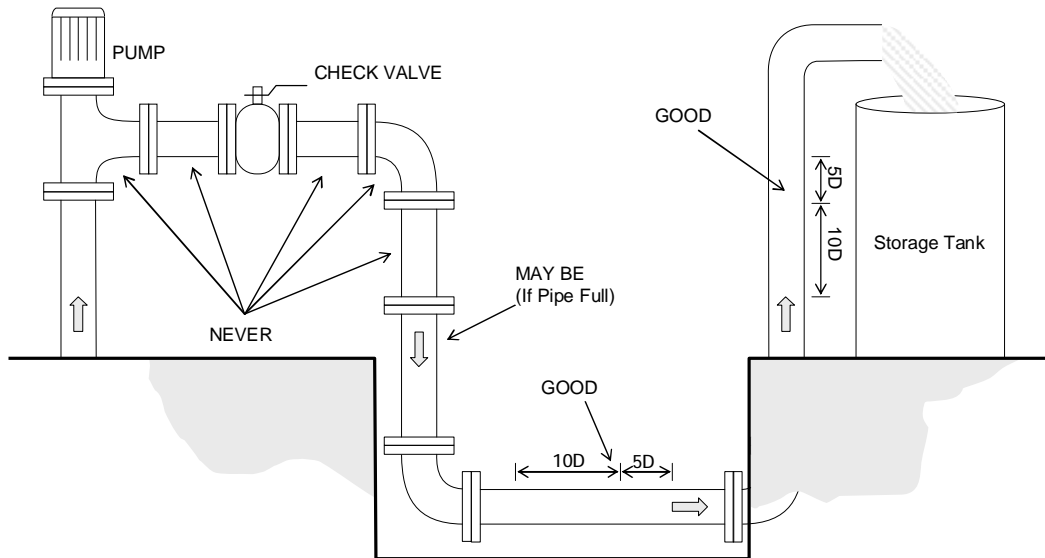

The site should have a straight pipe run length equal to at least 10 pipe diameters upstream and 5 pipe diameters downstream from any throttling valves or other flow disturbance producing elements, such as pipe reducers, elbows, tees, etc.

Ensure that the pipe surface temperature at the measuring point is within the transducer temperature limits.

Consider the inside condition of the pipe carefully. If possible, select a section of pipe where the inside is free excessive corrosion or scaling.

Choose a section of sound conducting pipe.

Examples acceptable measurement site selection is illustrated on the figure on the below.

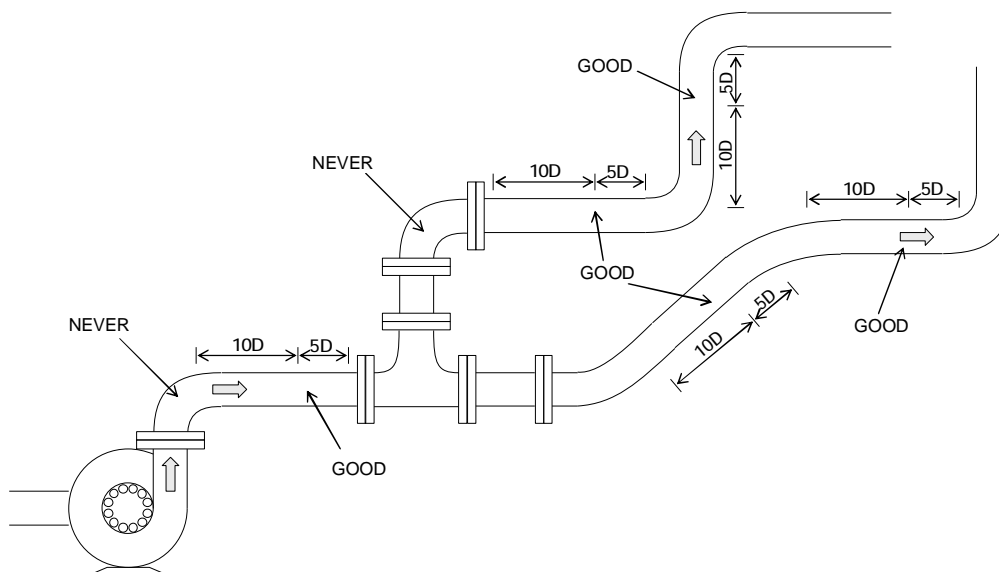

4. Transducer Installation

4.1. Installing the transducers

Before installing the transducers, clean the pipe surface where the transducers are to be mounted. Remove any rust, scale or loose paint and make a smooth surface. Choose a section of sound conducting pipe for installing the transducers. Apply a wide band of sonic coupling compound down the center of the face of each transducer as well as on the pipe surface, and then attach the transducers to the pipe with the straps provided and tighten them securely.

Note:

The two transducers should be mounted at the pipe's centerline on horizontal pipes.

Make sure that the transducer mounting direction is parallel with the flow.

During the installation, there should be no air bubbles or particles between the transducer and the pipe wall. On horizontal pipes, the transducers should be mounted in the 3 o'clock and 9 o'clock positions of the pipe section in order to avoid any air bubbles inside the top portion of the pipe. (Refer to Transducer Mounting). If the transducers cannot be mounted horizontally symmetrically due to limitation of the local installation conditions, it may be necessary to mount the transducers at a location where there is a guarantee full pipe condition (the pipe is always full of liquid).

4.1.1. Transducer spacing

After entering the required parameters, the spacing between the ENDS of the two transducers is considered as the standard transducer spacing(Refer to Top View on transducer mounting methods). Check the data displayed in Window M25 and space the transducers accordingly.

4.1.2. Transducer Mounting Methods

Four transducer mounting methods are available. They are respectively: V method, Z method, N method and W method. The V method is primarily used on small diameter pipes (DN100~400mm, 4"~16"). The Z method is used in applications where the V method cannot work due to poor signal or no signal detected. In addition, the Z method generally works better on larger diameter pipes (over DN300mm, 12") or cast iron pipes.

The N method is an uncommonly used method as well as is the W method. They are used on smaller diameter pipes (below DN50mm, 2").

4.1.3. V Method

The V method is considered as the standard method. It usually gives a more accurate reading and is used on pipe diameters ranging from 25mm to 400mm (1~16") approximately. Also, it is convenient to use, but still requires proper installation of the transducer, contact on the pipe at the pipe's centerline and equal spacing on either side of the centerline.

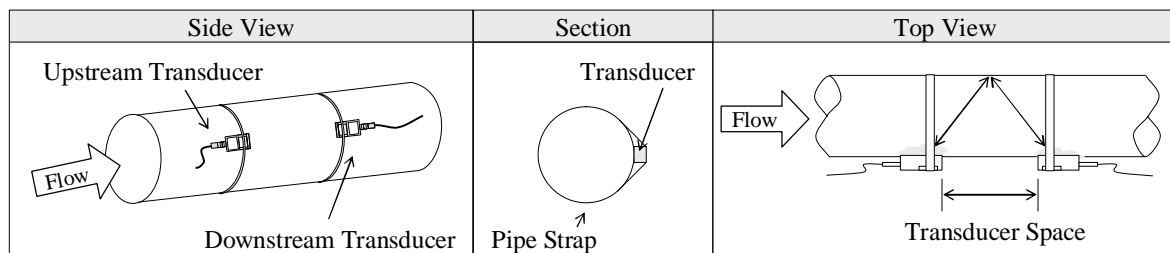

4.1.4. Z Method

The signal transmitted in a Z method installation has less attenuation than a signal transmitted with the V method. This is because the Z method utilizes a directly transmitted (rather than reflected) signal which transverses the liquid only once.

The Z method is able to measure on pipe diameters ranging from 100mm to 3000mm (4”~120”) approximately. Therefore, we recommend the Z method for pipe diameters over 300mm (12”).

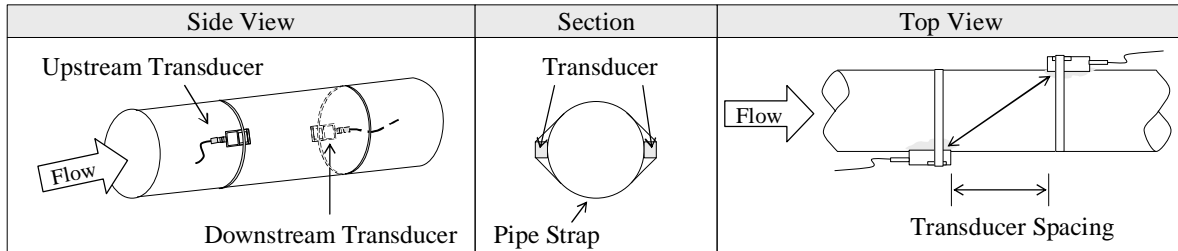

4.1.5. N Method (not commonly used)

With the N method, the sound waves traverse the fluid twice and bounce three times off the pipe walls. It is suitable for small pipe diameter measurement.

The measurement accuracy can be improved by extending the transit distance with the N method (uncommonly used).

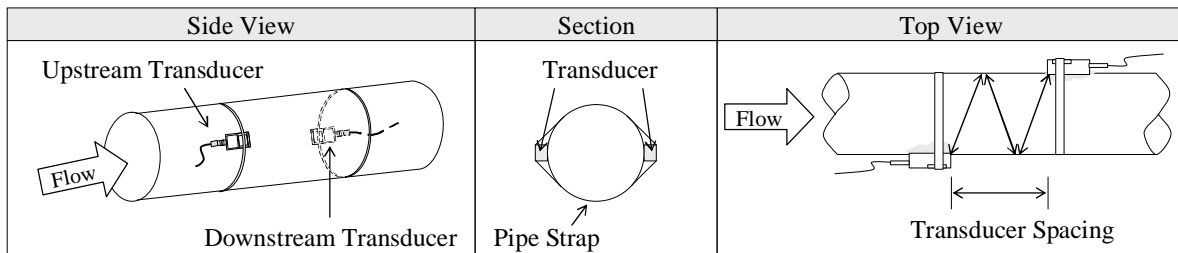

4.1.6. W Method (very rarely used)

As with the N method, the measurement accuracy can also be improved by extending the transit distance with the W method. The sound wave traverses the fluid four times and bounces four times off the pipe walls. It is suitable for very small pipe (diameters less than 50mm, 2”).

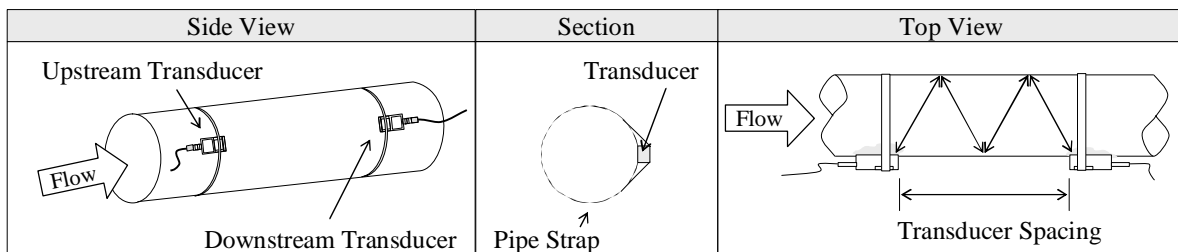

4.2. Transducer Mounting Inspection

Check to see if the transducer is installed properly and if there is an accurate and strong enough ultrasonic signal to ensure proper operation and high reliability of the transducer. It can be confirmed by checking the detected signal strength, total transit time, delta time as well as transit time ratio.

The “mounting” condition directly influences the flow value accuracy and system long-time running reliability. In

most instances, only apply a wide bead of sonic coupling compound lengthwise on the face of the transducer and stick it to the outside pipe wall to get good measurement results. However, the following inspections still need to be carried out in order to ensure the high reliability of the measurement and long-term operation of the instrument.

4.2.1. Signal Strength

Signal strength (displayed in Window M90) indicates a detected strength of the signal both from upstream and downstream directions. The relevant signal strength is indicated by numbers from 00.0~99.9. 00.0 represents no signal detected while 99.9 represent maximum signal strength.

Normally, the stronger the signal strength detected, the longer the operation of the instrument reliably, as well as the more stable the measurement value obtained.

Adjust the transducer to the best position and check to ensure that enough sonic coupling compound is applied adequately during installation in order to obtain the maximum signal strength.

System normally requires signal strength over 60.0, which is detected from both upstream and downstream directions. If the signal strength detected is too low, the transducer installation position and the transducer mounting spacing should be re-adjusted and the pipe should be re-inspected. If necessary, change the mounting to the Z method.

4.2.2. Signal Quality (Q value)

Q value is short for Signal Quality (displayed in Window M90). It indicates the level of the signal detected. Q value is indicated by numbers from 00~99. 00 represents the minimum signal detected while 99 represent the maximum.

Normally, the transducer position should be adjusted repeatedly and coupling compound application should be checked frequently until the signal quality detected is as strong as possible.

4.2.3. Total Time and Delta Time

“Total Time and Delta Time”, which displays in Window M93, indicates the condition of the installation. The measurement calculations in the flowmeter are based upon these two parameters. Therefore, when “Delta Time” fluctuates widely, the flow and velocities fluctuate accordingly. This means that the signal quality detected is too poor. It may be the resulted of poor pipe-installation conditions, inadequate transducer installation or incorrect parameter input.

Generally, “Delta Time” fluctuation should be less than $\pm 20\%$. Only when the pipe diameter is too small or velocity is too low can the fluctuation be wider.

4.2.4. Transit Time Ratio

Transit Time Ratio indicates if the transducer mounting spacing is accurate. The normal transit time ratio should be 100 ± 3 if the installation is proper. Check it in Window M91.

Attention

If the transit time ratio is over 100 ± 3 , it is necessary to check:





- (1) If the parameters (pipe outside diameter, wall thickness, pipe material, liner, etc.) have been entered correctly,
 - (2) If the transducer mounting spacing is accordance with the display in Window M25,
 - (3) If the transducer is mounted at the pipe's centerline on the same diameter,
 - (4) If the scale is too thick or the pipe mounting is distorted in shape, etc.
-

Warnings

- (1) Pipe parameters entered must be accurate; otherwise the flowmeter will not work properly.
- (2) During the installation, apply enough coupling compounds in order to stick the transducer onto the pipe wall. While checking the signal strength and Q value, move the transducer slowly around the mounting site until the strongest signal and maximum Q value can be obtained. Make sure that the larger the pipe diameter, the more the transducer should be moved.
- (3) Check to be sure the mounting spacing is accordance with the display in Window M25 and the transducer is mounted at the pipe's centerline on the same diameter.
- (4) Pay special attention to those pipes that formed by steel rolls (pipe with seams), since such pipe is always irregular. If the signal strength is always displayed as 0.00, that means there is no signal detected. Thus, it is necessary to check that the parameters (including all the pipe parameters) have been entered accurately. Check to be sure the transducer mounting method has been selected properly, the pipe is not worn-out, and the liner is not too thick. Make sure there is indeed fluid in the pipe or the transducer is not very close to a valve or elbow, and there are not too many air bubbles in the fluid, etc. With the exception of these reasons, if there is still no signal detected, the measurement site has to be changed.
- (5) Make sure that the flowmeter is able to run properly with high reliability. The stronger the signal strength displayed, the higher the Q value reached. The longer the flowmeter runs accurately, the higher the reliability of the flow rates displayed. If there is interference from ambient electromagnetic waves or the signal detected is too poor, the flow value displayed is not reliable; consequently, the capability for reliable operation is reduced.
- (6) After the installation is complete, power on the instrument and check the result accordingly.

5. Operating Instructions

5.1. System Normal Identification

Press the    keys. If the letter “*R” displays on the screen, it indicates system normal.

If the letter “E” is displayed, it indicates that the current loop output is over ranged by 120%. This refers to the settings in Window M57. Enter a larger value in Window M57, and the letter “E” will disappear. It can be ignored if no current loop output is used.

If the letter “Q” is displayed, it indicates that the frequency output is over ranged by 120%, and this refers to the settings in Window M69. Increase the input value in Window M69, and the letter “Q” will disappear. It can be ignored if no frequency output is used.

If the letter “H” is displayed, it indicates that the ultrasonic signal detected is poor. For more information, please refer to “Error Diagnoses”.

If the letter “G” is displayed, it indicates that system is adjusting the signal gain prior to the measurement. Also, it means system normal. Only when the adjustment takes too long without stopping, can system be identified as abnormal.

Letter “I” indicates no signal is being detected. Check the transducer wiring connections are correct, the transducers are installed firmly, etc.

Letter “J” indicates a hardware defect exists. Normally, such defect is temporary; it could be eliminated by system reboot (power off and restart).

For further information, please refer to “Error Diagnoses”.

5.2. Zero Set Calibration

Once zero flow occurs, a zero point may indicate on each measuring instrument, i.e. as the measurement value reaches zero flow, it is indicated as zero. It is necessary to establish the true zero flow condition and program that set point into the instrument.

If the zero set point is not at true zero flow, a measurement difference may occur. The smaller the physical measurement capacity is, the larger the measurement difference from the zero point will exist. Only when zero point reduced to a definite degree, as compared with the physical measurement capacity, can the measuring difference from zero point be ignored.

For an ultrasonic flowmeter, the measurement difference from zero point cannot be ignored at low flow. It is necessary to perform a zero set calibration to improve low flow measurement accuracy.

5.3. Scale Factor

Scale factor refers to the ratio between “actual value” and “reading value”. For example, when the measurement is 2.00, and it is indicated as 1.98 on the instrument, the scale factor reading is $2/1.98$. This means that the best scale factor constant is 1.

However, it is difficult to keep the scale factor as “1” on the instrument especially in batch control operations. The difference is called “consistency”. High quality products always require high consistency.

The scale factor default is “1” for each instrument prior to shipment from the factory. The reason is that the scale factors in the Flowmeter are only limited by two parameters, i.e. the crystal oscillation frequency and the transducer. It has no relation to any circuit parameters.

During operation, there still exists possible difference in pipe parameters, etc. The “scale factor” may be necessary when used on different pipes. Thus, scale factor calibration is specially designed for calibrating the differences that result from application on different pipes. The scale factor entered must be one that results from actual calibration.

5.4. System Lock (Unlock)

System lock is readable but uninterested to prevent operation error due to unauthorized tampering by unauthorized personnel.

Press the **Menu** **4** **7** **ENT** keys, move **▲/+** or **▼/-** key to select “Lock”, press the **ENT** key, enter a 1~4 numerically long password, and then press the **ENT** key to confirm.

Unlock using the selected password only. Press **Menu** **4** **7** **ENT**, move **▲/+** or **▼/-** to select “Unlock”, press **ENT**, enter the correct password, then press **ENT** to confirm.

Keep the password in mind or recorded in a safe place or the instrument cannot be used.

5.5. 4~20mA Current Loop Verification

Possessing a current loop output exceeding an accuracy of 0.1%, the flowmeter is programmable and configurable with multiple output modules such as 4 ~20mA or 0~20mA. Select in Window M55. For details, please refer to “Windows Display Explanations”.

In Window M56, enter a 4mA flow value. Enter the 20mA flow value in Window M57. For example, if the flow range in a specific pipe is 0~1000m³/h, enter 0 in Window M56 and 1000 in Window M57. If the flow ranges from -1000~0~2000m³/h, configure the 20~4~20mA module by selecting Window M55 when flow direction is not an issue. Enter 1000 in Window M56 and 2000 in Window M57. When flow direction is an issue, module 0~4~20mA is available. When the flow direction displays as negative, the current output is in range of 0~4mA, whereas the 4~20mA is for the positive direction. The output module options are displayed in Window M55. Enter “-1000” in Window M56 and 2000 in Window M57.

Calibrating and testing the current loop is performed in Window M58. Complete the steps as follows:

Press **Menu** **5** **8** **ENT**, move **▲/+** or **▼/-** to display “0mA”, “4mA”, “8mA”, “16mA”, “20mA” readings, connect an ammeter to test the current loop output and calculate the difference. Calibrate it if the difference is within tolerance.

Check the present current loop output in Window M59 as it changes along with change in flow.

5.6. Frequency Output

The flowmeter is provided with a frequency output transmitter function. The high or low frequency output displayed indicates the high or low flow rate reading. The user can reset the frequency output as well as flow rate per his requirements

For example: if a pipe flow range is 0~3000m³/h, the relative frequency output required is 123~1000Hz, and the configuration is as follows:

In Window M68 (low limit frequency output flow value), input 0;

In Window M69 (high limit frequency output flow value), input 3000;

In Window M67 (low limit frequency), input 123;

There is no output circuit specially assigned to frequency output. It only can be transmitted through OCT, i.e. select Window M78 (item “13. FO”).

5.7. Totalizer Pulse Output

Each time the flowmeter reaches a unit flow, it may generate a totalizer pulse output to an remote counter. To configure the unit flow, please refer to Windows M32 and M33.

The totalizer pulse output can be transmitted through OCT or a relay. So, it is necessary to configure OCT and the relay accordingly. (Please refer to Window M78 and M79).

For example, if it is necessary to transmit the positive totalizer pulse through a relay, and each pulse represents a flow of 0.1m³; the configuration is as follows:

In Window M33, select totalizer the flow unit “Cubic Meters (m³)”;

In Window M34, select the scale factor “x0.1”;

In Window M79, select “9. Positive totalizer pulse output”;

**Attention**

Make sure to select a suitable totalizer pulse, since the output may be extended if it is too large. If it is too small, the relay may activate too frequently and may probably shorten its life. Furthermore, if it operates too fast, it may generate a pulse loss error. Therefore, a rate of 1~60/minute is recommended.

5.8. Alarm Programming

The flowmeter has two programmable alarms: audible alarm and on off output alarm.

The audible alarm generates an internal beeper. Select the BEEPER trigger in Window M77.

The on-off output alarm is generated through OCT or transmission to an external circuit by opening or closing a relay. The on-off output signal is activated under the following conditions:

- (1) Signal not detected;
- (2) Poor signal detected;
- (3) The flowmeter is not ready for normal measurement;
- (4) The flow is in the reverse direction (back flow).
- (5) The analog outputs exceed span by 120%.
- (6) The frequency output exceeds span by 120%.
- (7) The flow rate exceeds the ranges configured (Configure the flow ranges using the software alarm system. There are two software alarms: Alarm#1 and Alarm #2. The lower limit value for Alarm#1 is configured in Window M73, and the upper limit value is configured in Window M74. As for Alarm#2, the lower limit value is in M75 and the upper one is in Window M76).

Example 1: To program the relay output alarm, activated when flow rate exceeds 300~1000m³/h:

- (1) In Window M73, input 300;
- (2) In Window M74, input 1000;
- (3) In Window M79, select item 6: "6. Alarm #1 limit exceed".

Example 2: To program OCT output alarm signal, activated when flow rate exceeds 100~500m³/h; relay output alarm signal activated when flow rate exceeds 600~1000m³/h:

- (1) In Window M73, input 100;
- (2) In Window M74, input 500;
- (3) In Window M75, input 600;
- (4) In Window M76, input 1000;
- (5) In Window M78, select item 6: "6. Alarm #1".
- (6) In Window M79, select item 7: "7. Alarm #2".

5.9. Batch Controller

The batch controller is able to perform flow quantity control, or the batching of specific volumes to control events in product production or chemical dosing, etc. The internal batch controller in the flowmeter is able to take the high or low end of analog input signals as an input, or through the keypad, to perform control functions. The output can be transmitted through OCT or a relay.

When taking analog inputs as control signals, input an analog output which is over 2mA through the analog input terminal to indicate the condition of "1"; current "0" indicates the condition of "0".

In Window M78(OCT output), M79(relay output) or M80(Flow Batch CTRL), select Item 8 "Batch controller" and the OCT or relay output will generate output signals.

Enter the batch value in Window M81. Start the batch controller after that. For details, please refer to “Windows Display Explanations”.

5.10. Analog Output Calibration



Attention

Each flowmeter has been calibrated strictly before leaving factory. It is unnecessary to carry through this step except when the current value (detected while calibrating the current loop) displayed in Window M58 is not identical with the actual output current value.

The hardware detect window must be activated prior to calibration. The procedure is as follows:

Press **Menu** **▼/→** **0** **ENT** enter password “4213068”, then press **ENT** to activate the detect menu. With no effect to next power on, this window will close automatically as soon as the power is turned off.

Press **Menu** **▼/→** **1** **ENT** to calibrate the current loop 4mA output. Use an ammeter to measure the current loop output current. At the same time, move **▲/+** or **▼/-** to adjust the displayed numbers. Watch the ammeter until it reads 4.00. Stop at this point, the 4mA has been calibrated.

Then, press **ENT** to calibrate the current loop 20mA output. The method is as same as in 4mA calibration.

The results is saved in EEPROM. Switch off the power supply has not lost.

5.11. Use of the memory card

5.11.1. Specifications

Memory: 1GB (Standard)

Data collection update rate: User Selectable: 5 seconds to 13000 seconds (3.6 hours). .

Data content: date and time, flow, velocity, cumulated flow, positive totalizer, negative totalizer, heat quantity

File system format: FAT16

File type: plain text file (.txt)

File number: maximum 512pcs

Filename format: yymmdd (yy - year, mm - month, dd - date)

SD Data format:

1= yy-mm-dd, hh:mm:ss

2= +3.845778E+01m³/h

3= +1.451074E+00m/s

4= -0000010E+0m³

5= +0000002E+0m³

6= -0000012E+0m³

7=+7.1429E-01KJ/s

8=+3.9721E+03KJ

9=+4.573242E+01

10=+4.338866E+01

It can save 120bytes of data each time. When the capacity of the SD card is full, the new data will override the earliest files automatically.

5.11.2. Install or Remove while the meter is powered ON

If the operator desires to insert or remove the SD card with power on, the following operation is to be used: Shown as the picture above, Transferred to switch “OFF” position. Observe the “Memory” indicator light turn off. It is then safe to remove or install the SD Card. Once reinstalled, Transferred to switch “ON” position, observe the “Memory” indicator light is on, now the SD card can continue to log data.

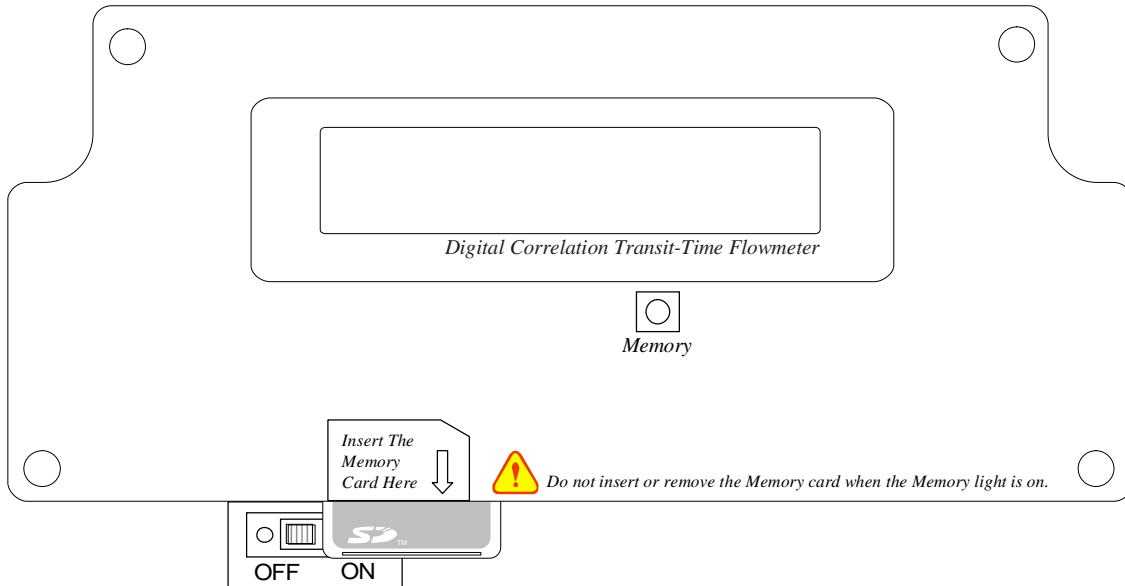

5.11.3. Reading the SD Data Externally

Remove the SD card from the Flowmeter. The operator may then use a PC carder reader to read the data in the card. On the PC the operator can save, edit and print the data in the SD card, and then recall and analyze the data. Care should be taken while working with the data on the SD card on a PC.

Attention



Do not remove the SD card from the reader while actively working with the data. Data should be saved and stored in a separate location on the PC, and then processed from that file location. processing the data directly from the SD card file location on the PC could result in lost or corrupt data if the SD card is removed while still being processed.

5.11.4. Reading the SD Data Internally with the Instrument powered ON

Open the cover of the meter; connect the flowmeter to a PC via RS232. The operator can read and work with the data in the SD card with the “Converter” software provided with the flowmeter:

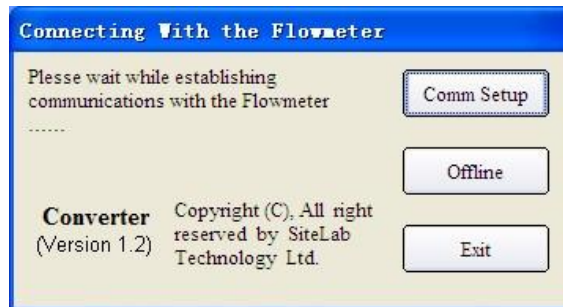

Bump into “Comm Setup”, Set up communications port (Generally COM1) and baud rate:



After connecting on Flowmeter, Shown below (If not connected to flow meter, you can click on "Offline" button interface into the document conversion):`

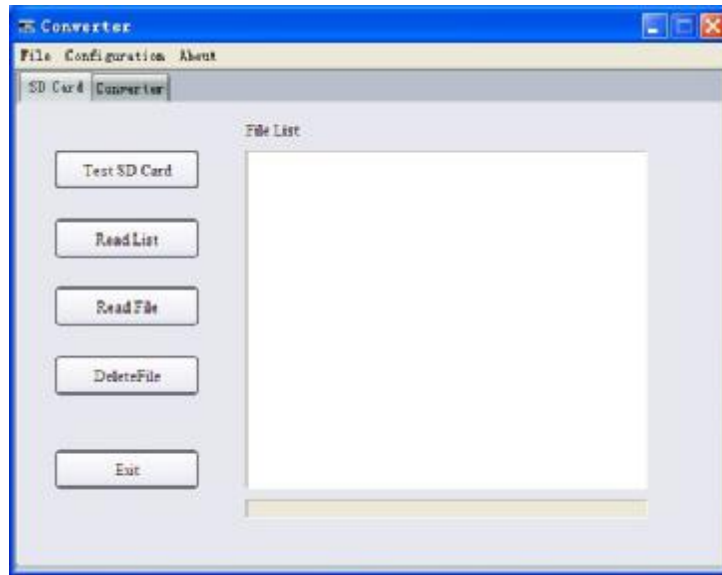

Due to the expanded memory (EMS) capacity of the flowmeter is extremely small as compared with the SD memory card; the transfer speed is rather slow for some commands. So we suggest: it is better to read the SD data externally (remove the card from the flowmeter to insert it into your PC).

- (1) Click "Test SD card", if the panel on the LED is lit will be the pop-up "The SD card is OK" a window that SD card is working.
- (2) Click on "Read list" to return to the SD card catalog of all the documents.
- (3) Then click on "Read File" will be a reading of the progress of the document.

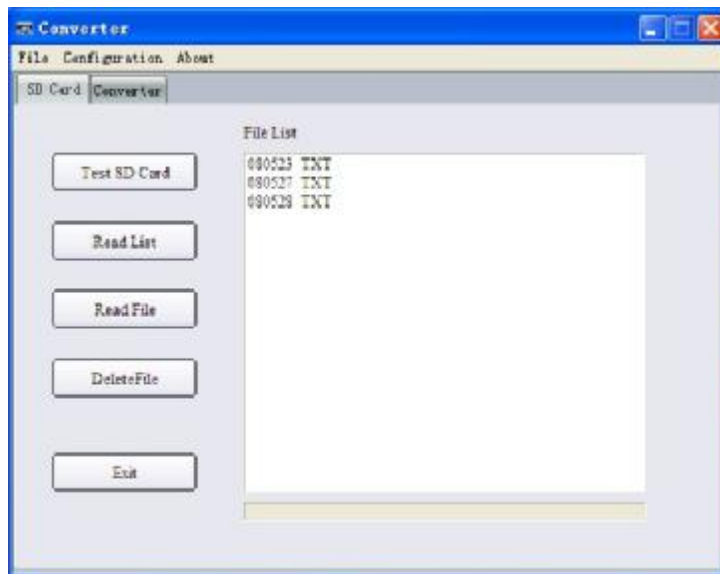

After the reading, will pop up "The File has been read" window and Converter.exe the root directory of storage or set up by reading the paper and check the contents of the file format is normal.

Return to the directory, select a file (such as 080523. TXT), then click the "Delete File", then delete confirmed that the successful return to delete to delete success tips, if chosen by the paper as a document of the day, then returned to tips can not be deleted.

5.11.5. File converter tool

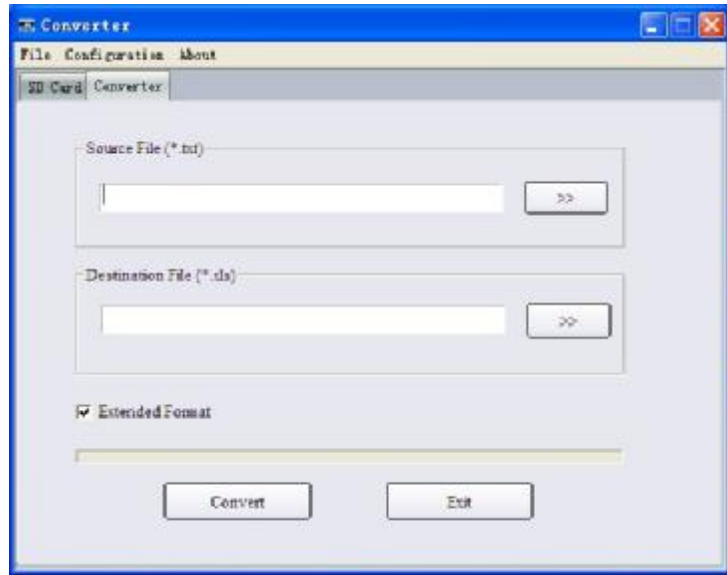

The files saved in the SD card are in text format (.TXT). If the operator desires to convert it to Excel format (.XLS), the file-conversion tool (Converter.EXE) may be found in the CD shipped with the flowmeter. This program must be run in the WINDOWS operating system, the interface is as follows:



Select the file to be converted in “Source File (*.txt)”, enter the directory path and the filename in “Destination File (*.xls)”, then press “Convert”. The conversion is completed.

5.12 Recover the Factory Default

If it is necessary to recover the factory default,

Press   keys after the above-mentioned characters are displayed on the screen.

Generally, it is unnecessary to activate this function except during the initial installation.

5.13.ESN

We provide the flowmeter with a unique electronic serial number to identify each flowmeter for the convenience of the manufacturer and customers. The ESN, instrument types and versions are able to view in Window M61.



Attention

Other Operating Refer to “Windows Display Explanations”

6. Windows Display Explanations

6.1. Windows Display Codes

Flow Totalizer Display	
00	Flow Rate/Net Totalizer
01	Flow Rate/Velocity
02	Flow Rate/POS Totalizer
03	Flow Rate/NEG Totalizer
04	Date Time/Flow Rate
05	Instantaneous Caloric/Totalized Caloric
06	Analog Input AI1, AI2
08	System Error Codes
09	Net Flow Today
Initial Parameter setup	
10	Pipe Outer Perimeter
11	Pipe Outer Diameter
12	Pipe Wall Thickness
13	Pipe Inner Diameter
14	Pipe Material
15	Pipe Sound Velocity
16	Liner Material
17	Liner Sound Velocity
18	Liner Thickness
20	Fluid Type
21	Fluid Sound Velocity
22	Fluid Viscosity
23	Transducer Type
24	Transducer Mounting
25	Transducer Spacing
26	Parameter Setups
27	Cross-sectional Area
28	Holding with Poor Sig
29	Empty Pipe Setup
Flow Units Options	
30	Measurement Units
31	Flow Rate Units
32	Totalizer Units
33	Totalizer Multiplier
34	Net Totalizer
35	POS Totalizer
36	NEG Totalizer
37	Totalizer Reset
38	Manual Totalizer
Setup Options	
40	Damping
41	Low Flow Cutoff Value
42	Set Zero
43	Reset Zero

44	Manual Zero Point
45	Scale Factor
46	Network identifying address code
47	System Lock
52	Energy Record
Input and output setup	
55	CL Mode Select
56	CL 4mA Output Value
57	CL 20mA Output Value
58	CL Check
59	CL Current Output
60	Date and Time
61	Software Version and ESN
63	AI1 Value Range
64	AI2 Value Range
66	AI3 Value Range
67	FO Frequency Range
68	Low FO Flow Rate
69	High FO Flow Rate
70	LCD Backlit Option
72	Working Timer
73	Alarm #1 Low Value
74	Alarm #1 High Value
75	Alarm #2 Low Value
76	Alarm #2 High Value
78	OCT Output Setup
79	Relay Output Setup
80	Flow Batch CTRL
81	Flow Batch Controller
82	Date Totalizer
83	Automatic Correction
Calorimetry	
84	Energy Units Select
85	Temperature Select
86	Specific Heat Select
87	Energy Totalizer ON/OFF
88	Energy Multiplier
89	Reset Energy Totalizer
Diagnoses	
90	Signal Strength and Quality
91	TOM/TOS*100
92	Fluid Sound Velocity
93	Total Time and Delta
94	Reynolds Number and Factor
95	Data Interval

Appendix	
+0	Power ON/OFF time
+1	Total Working Hours
+2	Last Power Off Time
+3	Last Flow Rate
+4	ON/OFF Times
+5	Calculator

NOTE: The menu features from other manufacturers to retain.

6.2. Display explanation

While reading this section, please compare it with the instrument in order to improve your understanding.

Menu 00

Flow Rate / Net Totalizer

Display flow rate and net totalizer.

If the net totalizer has been turned off (refer to M34), the net totalizer value displayed is the total prior to its turn off.

Flow 0.1154m3/h *R
NET 0x1m3

Menu 01

Flow Rate / Velocity

Display flow rate and velocity.

Flow 0.1129m3/h *R
Vel 1.0415m/s

Menu 02

Flow Rate / Positive Totalizer

Display flow rate and positive totalizer.

Select the positive totalizer units in Window M31.

If the positive totalizer has been turned off, the positive totalizer value displayed is the total prior to its turn off.

Flow 0.1129m3/h *R
POS 0x1m3

Menu 03

Flow Rate / Negative Totalizer

Display flow rate and negative totalizer.

Select the negative totalizer value in Window M31.

If the negative totalizer has been turned off (refer to M36), the value displayed is the total prior to turn off.

Flow 0.1120m3/h *R
NEG 0x1m3

Menu 04

Date Time / Flow Rate

Display the current date time and flow rate.

The time setting method is found in Window M60.

03-04-03 15:49:40 *R
Flow 0.1116 m3/h

Menu 05

Caloric / Totalized Caloric

Display Instantaneous Caloric and Totalized Caloric.

EFR 0.0000GJ/h *R
E.T 0E+0 GJ

Menu 0 6

Analog Input Value

Display Analog Input AI1, AI2 current value and corresponding temperature value.

AI 1= 4.0000: 20.000
AI 2= 8.0000: 40.000

Menu 0 8

System Error Codes

Display the working condition and the system error codes. More than one error code can occur at the same time.

The explanations of error codes and detailed resolution methods can be found in "Error Diagnoses".

*R -----
System Normal

Menu 0 9

Net Flow Today

Display net total flow today.

Net Flow Today M09
0.458748 m3

Menu 1 0

Pipe Outer Perimeter

Enter the pipe outer perimeter.If the diameterof the know, enter it in window M11.

Pipe Outer Perimeter
157 mm

Menu 1 1

Pipe Outer Diameter

Enter the pipe outside diameter, The pipe outside diameter must range from 10mm to 6000mm.

Pipe Outer Diameter
50 mm

Menu 1 2

Pipe Wall Thickness

Enter the pipe wall thickness. If the pipe inside diameter is already known, skip this window and enter it in Window M13.

Pipe Wall Thickness
4 mm

Menu 1 3

Pipe Inner Diameter

Enter the pipe inside diameter. If the pipe outside diameter and pipe wall thickness has been entered, press  to skip this window.

Note: Enter either pipe wall thickness or pipe inside diameter.

Pipe Inner Diameter
52 mm

Menu 1 4

Pipe Material

Enter pipe material. The following options are available (by ,  buttons or numerical keys):

0. Carbon Steel	1. Stainless Steel
2. Cast Iron	3. Ductile Iron
4. Copper	5. PVC
6. Aluminum	7. Asbestos
8. Fiber Glass-Epoxy	9. Other

Refer to item 9 “Other”; it is possible to enter other materials, which are not included in previous eight items. Once item 9 is selected, the relevant pipe sound velocity must be entered in Window M15.

Pipe Material [14
0. Carbon Steel

Menu 1 5

Pipe Sound Velocity

Enter pipe sound velocity. This function is only used when item 9 “Other” is selected in Window M14. At the same time, this window cannot be visited. System will calculate automatically according to the existing parameters.

Pipe Sound Velocity
2800 m/s

Menu 1 6

Select the Liner Material

The following options are available:

0. None ,No Liner	1. Tar Epoxy
2. Rubber	3. Mortar
4. Polypropylene	5. Polystryol
6. Polystyrene	7. Polyester
8. Polyethylene	9. Ebonite
10. Teflon	11. Other

Item 11 “Other” is available to enter other materials that are not included in previous ten items. Once the “Other” is selected, the relevant liner sound velocity must be entered in Window M17.

Linner Material [16
0. None, No Liner

Menu 1 7

Liner Sound Velocity

Enter liner sound velocity. It only can be visited when item “ Other” in Window M16 is selected.

Linner Sound Velocity
2270 m/s

Menu 1 8

Liner Thickness

Enter liner thickness. It only can be visited when a definite liner is selected in Window M16.

Linner Thickness [18
10 mm

Menu 2 0

Select Fluid Type

The following options are available:

0. Water	1. Sea Water
2. Kerosene	3. Gasoline
4. Fuel Oil	5. Crude Oil
6. Propane (-45°C)	7. Butane (0°C)
8. Other	9. Diesel Oil
10. Castor Oil	11. Peanut Oil
12. Gasoline #90	13. Gasoline #93
14. Alcohol	15. Water (125°C)

“Other” refers to any fluid. The relevant sound velocity must be entered in Window M21.

Fluid Type [20
0. Water

Menu 2 1

Fluid Sound Velocity

Enter the fluid sound velocity. It only can be used when item “Other” is selected in Window M20, i.e. it is unnecessary to enter all the fluids listed in Window M20.

Fluid Sound Velocity
1482.3 m/s

Menu 2 2

Fluid Viscosity

Enter fluid’s kinematics viscosity. It only can be used when item “Other” is selected in Window M20, i.e. it is unnecessary to enter all the fluids that listed in Window M20.

Fluid Viscosity [22
1.0038 cST

Menu 2 3

Select transducer type. Please select “0.Standard”.

Transducer Type [23
0. Standard

Menu 2 4

Transducer Mounting

Four mounting methods are available:

V(sound wave bounces 2 times)

Z(sound wave bounces once. The most commonly use method)

N (small pipe, sound wave bounces 3 times.)

W (small pipe, sound wave bounces 4times.)

Transducer Mounting
0. V

Menu 2 5

Transducer Spacing (this value is Calculated by the flowmeter)

The operator must mount the transducer according to the transducer spacing displayed (be sure that the transducer spacing must be measured precisely during installation). The system will display the data automatically after the pipe parameter had been entered.

Transducer Spacing
148.666 mm

Menu 2 6

Initial Parameter Setups and Save

Load and save the parameters. 18 different sets of setup conditions/groups are available to load and save by three methods (i.e.-you can load and save 18 different applications):

0. Entry to Save
1. Entry to Load
2. To Browse

Select "Entry to Save", press ENT. An ID code and the original parameters are displayed in the window. Press UP or DOWN ARROW to move the ID code, then press the ENT key again to save the current parameter in the current ID room.

When selecting "Entry to Load", press ENT, and the system will read and calculate the parameters automatically and display the transducer mounting spacing in Window M25.

Parameter Setups
Entry to SAVE

Menu 2 7

Cross-Sectional Area

Display the cross-sectional area inside the pipe.

Cross-sectional Area
31415.9 mm2

Menu 2 8

Holding with Poor Sig

Select "Yes" to hold last good flow signal displayed if the flowmeter experiences a poor signal condition. This function will allow continued data calculation without interruption.

Holding with Poor Sig
NO

Menu 2 9

Empty Pipe Setup

This value may be used to solve the problem of air traffic control. In the empty pipe, it may be because the flow meter signal transmission through the wall and show the "normal work", in order to avoid such a situation arise, set this value to flowmeter in the small signal of this is not a numerical measure.

Empty Pipe Setup [29
0



Measurement Units Options

Select the measurement unit as follows:

- 0. Metric
- 1. English

Factory default is metric.

Measurement Units In
0. Metric



Flow Rate Units Options

The following flow rate units are available:

- 0. Cubic Meters (m³)
- 1. Liters (l)
- 2. USA Gallons (GAL)
- 3. Imperial Gallons (Imp gal)
- 4. Million Gallons (mg)
- 5. Cubic Feet (cf)
- 6. USA Barrels (US bbl)
- 7. Imperial Barrels (Imp bbl)
- 8. Oil Barrels (Oil bbl)

The following time units are available:

- /Day /Hour
- /Min /Sec

Factory default is Cubic Meters/hour

Flow Rate Units [31
m³/h



Totalizer Units Options

Select totalizer units. The available unit options are as same as those found in Window M31. The user can select units as their required. Factory default is Cubic Meters.

Totalizer Units [32
Cubic Meter (m³)



Totalizer Multiplier Options

The totalizer multiplier acts as the function to increase the totalizer indicating range. Meanwhile, the totalizer multiplier can be applied to the positive totalizer, negative totalizer and net totalizer at the same time.

The following options are available:

- 0. X0.001(1E-3)
- 1. X0.01
- 2. X0.1
- 3. X1
- 4. X10
- 5. X100
- 6. X1000
- 7. X10000(1E+4)

Factory default factor is x1

Totalizer Multiplier
0. x0.001(1E-3)

Menu 3 4

ON/OFF Net Totalizer

On/off net totalizer. "ON" indicates the totalizer is turned on, while "OFF" indicates it is turned off.

When it is turned off, the net totalizer displays in Window M00 will not change. Factory default is "ON".

Net Totalizer [34
ON

Menu 3 5

ON/OFF POS Totalizer

On/off positive totalizer. "ON" indicates the flowmeter starts to totalize the value. When it is turned off, the positive totalizer displays in Window M02. Factory default is "ON".

POS Totalizer [35
ON

Menu 3 6

ON/OFF NEG Totalizer

ON/OFF negative totalizer. "ON" indicates the totalizer is turned on. When it is turned off, the negative totalizer displays in Window M03.

Factory default is "ON".

NEG Totalizer [36
ON

Menu 3 7

Totalizer Reset

Totalizer reset; all parameters are reset. Press ENT; move ▲/+ or ▼/- arrow to select "YES" or "NO". After "YES" is selected, the following options are available:

None, All, NET, POS, NEG

If it is necessary to recover the factory default, press ● ◀ keys after the above-mentioned characters are displayed on the screen.

Generally, it is unnecessary to activate this function except during the initial installation.

Totalizer Reset? [37
Selection

Menu 3 8

Manual Totalizer

The manual totalizer is a separate totalizer. Press ENT to start, and press ENT to stop it. It is used for flow measurement and calculation.

Manual Totalizer [38
Press ENT When Ready

Menu 4 0

The damping function will stabilize the flow display. Essentially, it is a part of the signal filter. Enter a coefficient. Increasing the coefficient increases the stability. However, the measurement displayed may be slightly delayed due to over damping. Logging too long may result in no response to real-time fluctuation,

Damping [40
10 sec

especially when flow rate fluctuates wildly. Therefore, damping should be kept at a minimum and increased just enough to reduce the fluctuation to an acceptable degree by 3 to 10 seconds.

The damping factor ranges from 0~999 seconds.0 indicates no damping; 999 indicate the maximum damping. Usually a damping factor of 3 to 10 is recommend in applications.

Menu 4 1

Low Flow Cutoff Value

If the flow rate falls below the low flow cutoff value, the flow indication is driven to zero. This function can prevent the flowmeter from reading flow after a pump as shut down but there is still liquid movement in the pipe, which will result in totalization error.

Generally, 0.03m/s is recommended to enter as the low flow cutoff point. The low flow cutoff value has no relation to the measurement results once the velocity increases over the low flow cutoff value

**Low Flow Cutoff Val.
0.01 m/s**

Menu 4 2

Set Zero

When fluid is in the static state, the displayed value is called “Zero Point”. When “Zero Point” is not at zero in the flowmeter, the difference is going to be added into the actual flow values and measurement differences will occur in the flowmeter.

Set zero must be carried out after the transducers are installed and the flow inside the pipe is in the absolute static state (no liquid movement in the pipe). Thus, the “Zero Point” resulting from different pipe mounting locations and parameters can be eliminated. The measuring accuracy at low flow is enhanced by doing this and flow offset is eliminated.

Press **ENT**, wait for the processing instructions at the bottom right corner to reach 0.

Performing Set zero with existing flow may cause the flow to be displayed as “0”. If so, it can be recovered via Window M43.

**Set Zero [42
Press ENT to go**

Menu 4 3

Reset Zero

Select “YES”; reset “Zero Point” which was set by the user.

**Reset Zero [43
NO**

Menu 4 4

Manual Zero Point

This method is not commonly used. It is only suitable for experienced operators to set zero under conditions when it is not preferable to use other methods. Enter

**Manual Zero Point [44
0 m3/h**

the value manually to add to the measured value to obtain the actual value. For example: Actual measured value = 250 m³/H Value Deviation = -10 m³/H

Flowmeter Display = 240 m³/H

Normally, set the value as “0”.

Menu 4 5

Scale Factor

The scale factor is used to modify the measurement results. The user can enter a numerical value other than “1” according to calibration results.

Scale Factor [45]
1

Menu 4 6

Network IDN

Input system identifying code, these numbers can be selected from 0~65535 except that 13 (0DH ENTER), 10 (0AH Newline), 42 (2AH *) and 38 (26H&) are reserved. System IDN is used to identify the flowmeter to a network.

Network IDN [46]
88

Menu 4 7

System Lock

Lock the instrument.

Once the system is locked, any modification to the system is prohibited, but the parameter is readable. “Unlock” using your designated password. The password is composed of 1 to 4 numbers.

System Lock [47]
**** Unlocked ****

Menu 5 2

Energy Record

When set to “ON”, SD Card records began thermal data; When set to “OFF”, SD Card records stop data record heat. The default setting is “OFF”.

Energy Record ON/OFF
OFF

Menu 5 5

Current Loop Mode Select

CL Mode Select [55]
0. 4 - 20 mA

Select the current loop mode. The following options are available:

- 0. 4-20mA Output Mode set up the output range from 4-20mA
- 1. 0-20mA Output Mode set up the output range from 0-20mA
- 2. RS232 controls 0-20mA set up to control by Serial Port
- 3. Turn off the current loop turn off the current loop to save battery life(Factory default value)
- 4. 20-4-20mA Mode set up the output range from 20-4-20mA
- 5. 0-4-20mA Mode set up the output range from 0-4-20mA
- 6. 20-0-20mA Mode set up the output range from 20-0-20mA

- 7. 4-20mA Corresponding Velocity set up the CL output range from 4-20mA
- 8. 4-20mA Corresponding Heat Flow set up the CL output range from 4-20mA

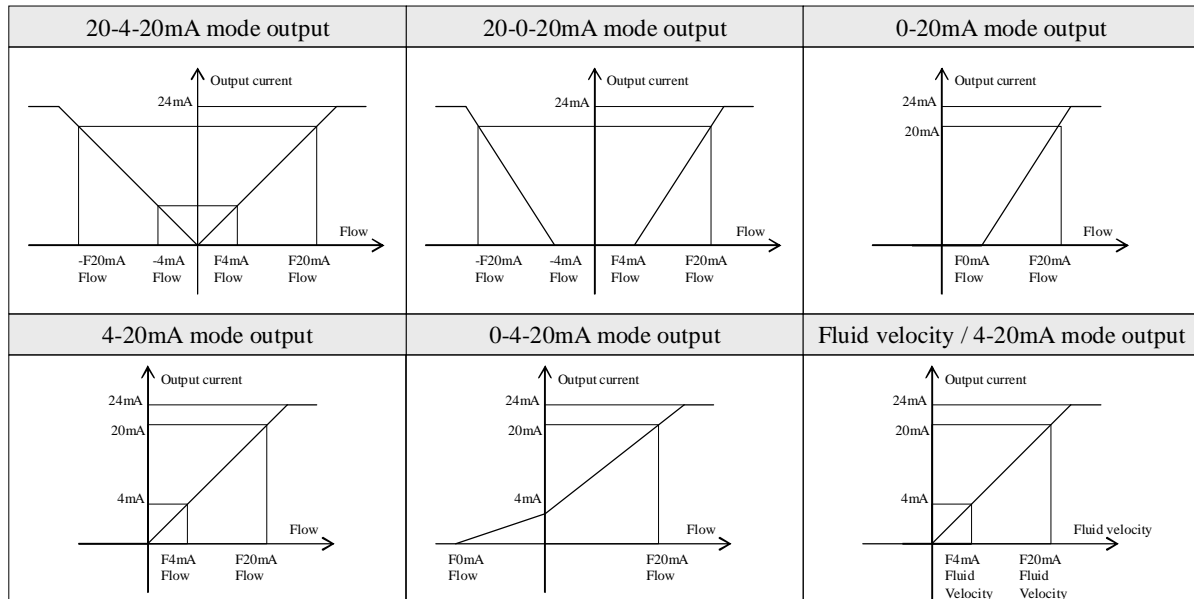

The Serial Port controls the output according to the command and parameter entered in the RS232 to output a definite current value through the current loop. The command formats are narrated in the command explanations to Serial Port controls. For example, if it is necessary to output a 6mA current through the current loop, it can be realized by setting Window M56 to the mode “0-20mA Via RS232” and giving a command as “AO6 (CR)”. This function is able to make the flowmeter operate a control valve conveniently.

Other different current output characteristics are displayed in above figures. The user can select one of them according to his actual requirements.

0. 4-20mA
1. 0 - 20 mA
2. 0 - 20 mA Via RS232
3. 4 - 20 mA VS. Fluid
4. 20-4-20 mA
5. 0-4-20 mA
6. 20-0-20 mA
7. 4-20mA vs. Vel.
8. 4-20mA vs. Energy

In six graphs shown above, flow F_{0mA} or F_{4mA} indicates the value that user entered in Window M57; and flow F_{20mA} indicates the value that customer entered in Window M58. In the 4-20mA and 0-20mA modes, F_{0mA} (or F_{4mA})and F_{20mA} can be selected as a positive or negative flow value as long as the two values are not the same. As for modes 20-4-20mA and 20-0-20mA, the flowmeter ignores the positive and negative value of the actual flow; therefore, both F_{0mA} (or F_{4mA})and F_{20mA} must be selected as positive flow values.

In mode 0-4-20mA, F_{0mA} must be select as a negative value and F_{20mA} as a positive value. Furthermore, in mode 4-20mA, the output current is indicated as velocity.



CL 4mA or 0mA Output Value

Set the CL output value according to the flow value at 4mA or 0mA.(4mA or 0mA are determined by the settings in Window M56). The flow unit’s options are as same as those in Window M31. Once “velocity 4-20mA”is selected in Window M56, the unit should

CL 4 mA Output Value
0 m3/h

be set as m/s.

Menu 5 7

20mA Output Value

Set the CL output value according to the flow value at 20mA. The flow unit is the as same as that found in Window M31.

CL 20mA Output Value
14400 m3/h

Menu 5 8

CL Check Verification

Check if the current loop has been calibrated before leaving the factory. Press **ENT** move **▲/+** or **▼/-** separately to display 0mA, 4mA till 24mA, and at the same time, check with an ammeter to verify that CL output terminals M31 and 32 agree with the displayed values. It is necessary to re-calibrate the CL if over the permitted tolerance. For more information, refer to “Analog Outputs Calibration”.

CL Checkup [58]
Press ENT WhenReady

Menu 5 9

CL Current Output

Display CL current output. The display of 10.0000mA indicates that CL current output value is 10.0000mA. If the difference between displaying value and CL output value is too large, the current loop then needs to be re-calibrated accordingly.

CL Current Output [59]
15.661 mA

Menu 6 0

Date and Time Settings

Generally, it is unnecessary to modify date time as the system is provided with a highly reliable perpetual calendar chip.

The format for setting time setting is 24 hours. Press **ENT**, wait until “>” appears, the modification can be made.

YY-MM-DD HH:MM:SS
03-04-04 10:05:04

Menu 6 1

ESN

Display electronic serial number (ESN) of the instrument. This ESN is the only one assigned to each flowmeter ready to leave the factory. The factory uses it for files setup and for management by the user.

Ultrasonic Flowmeter
S/N=05071188

Menu 6 2

COM Setup

The window used to set serial port. The Serial port for communications and other equipment. Its connection with the equipment of its serial port set of parameters must match. Window the first choice of data that baud

RS-232 Setup [62]
9600, None

rate, 9600,19200,38400,56000,57600,115200 choice.
The second option that in check,None.

Data length fixed to eight;

Stop bit for a fixed length;

Factory serial port parameters for the default
“9600,8,None,1”.

Menu 6 3

AI1 Value Range

In window 63 enter temperature value which 4mA and 20mA analog input represented. In this example window “10” represent 4mA corresponding temperature value, “100” represent 20mA corresponding temperature value.

AI 1 Value Range [63
10 - 100

Menu 6 4

AI2 Value Range

In window 64 enter temperature value which 4mA and 20mA analog input represented. See this window “10” represent 4mA corresponding value, “100” represent 20mA corresponding value.

AI 2 Value Range [64
10 - 100

Menu 6 5

AI3 Value Range

In window 65 enter temperature value which 4mA and 20mA analog input represented. See this window “10” represent 4mA corresponding value, “100” represent 20mA corresponding value.

AI 3 Value Range [65
10 - 100

Menu 6 7

Set FO Frequency Range

Set up low FO Frequency and high FO frequency range. It must be higher than the low FO frequency. Ranges from 1-9999Hz. Factory default is 2000 Hz.

Note: The frequency output is transmitted through OCT Serial Port; therefore the OCT must be set to the frequency output mode.

FO Frequency Range
1 - 5000

Menu 6 8

Low FO Flow Rate

Set up low FO flow rate, i.e. the corresponding flow value when output signal frequency is at the lowest FO frequency. For example, when the low FO frequency is 1000Hz, low FO flow rate is 100m3/h (when the frequency output is 1000Hz, then the low flow at this moment measured by the flowmeter is 100m3/h.

Low FO Flow Rate [68
0 m3/h

Menu 6 9

High FO Flow Rate

Enter the high FO flow rate, i.e. the corresponding flow value when frequency output signal is at highest FO frequency.

High FO Flow Rate [69
26550 m3/h

Menu 7 0

LCD Backlit Option

Select LCD backlit controls.

0.Always OFF, 1.Always ON, 2.Lighting For
“Always On” indicates that the backlight remains lit constantly; “Always Off” indicates that the backlit remains off constantly. Select “Time=”, then enter the desired backlighting time for “n” seconds; it indicates that after pressing the button, the backlighting will keep on for “n” seconds then turn off automatically. This function saves energy.

LCD Backlit Option
0. Always ON

Menu 7 2

Working Timer

Display the totalized working hours of the flowmeter since last reset. It is displayed by HH:MM:SS. If it is necessary to reset it, press (ENT), and select “YES”.

Working Timer [72
00000011:16:38

Menu 7 3

Alarm #1 Low Value

Enter the low alarm value. Both relevant alarms are turned on in Windows M78 and M79; any of the measured flow, which is lower than the low value, will activate the alarm in the OCT hardware or relay output signal.

Alarm #1 Low Value
0 m3/h

Menu 7 4

Alarm #1 High Value

Enter the high alarm value. Both relevant alarms are turned on in Windows M78 and M79; any of the measured flow, which is higher than the high value, will activate the alarm in the OCT hardware or relay output signal.

Alarm #1 High Value
14400 m3/h

Menu 7 5

Alarm #2 Low Value

Enter the alarm low value. Both relevant alarms are turned on in Windows M78 and M79; any measured flow, which is lower than the low value, will activate the alarm in the OCT hardware or relay output signal.

Alarm #2 Low Value
0 m3/h

Menu 7 6

Alarm #2 High Value

Enter the alarm high value.

Alarm #2 High Value
14400 m3/h

Menu 7 8

OCT Output Setup

The OCT output in the flowmeter is a kind of isolated collector open circuit output with programmable open and close qualifications. The user can program the open and close functions under the following conditions: the system alarm signals are being activated or the totalizer pulse is being transmitted.

The frequency output signal is also transmitted from the OCT. When it functions as the frequency output, other functions are unavailable.

OCT Output Setup [78
16. Fluid changed

The following signal options are available:

0. No Signal	1. Poor Signal
2. Not Ready (No*R)	3. Reverse Flow
4. AO Over 100%	5. FO Over 120%
6. Alarm #1	7. Alarm #2
8. Batch Control	9. POS Int Pulse
10. NEG Int Pulse	11. NET Int Pulse
12. Energy Pulse	13. FO
14. FO via RS-232C	15. ON/OFF viaRS232
16. Fluid changed	17. Not Using

Menu 7 9

Relay Output Setup

The relay output in the flowmeter is programmable. The user can program the open and close functions under the following conditions: the system alarm signals are activated or the totalizer pulse is transmitting. The relay is single-pole and constant-on for external instrument controls. The following options are available:

RELAY Output Setup
8. Batch Control

0. No Signal	1. Poor Signal
2. Not Ready (No*R)	3. Reverse Flow
4. AO Over 100%	5. FO Over 120%
6. Alarm #1	7. Alarm #2
8. Batch control	9. POS Int Pulse
10. NEG Int Pulse	11. NET Int Pulse
12. Energy Pulse	13. ON/OFF via RS232
14. Fluid changed	15. Not Using

Menu 8 0

Flow Batch CTRL

The choice of quantitative window of the launch control signal controller. The following options are available:

Flow Batch CTRL by
O.Key I nput

0.Key Input	1.AI1 Up Edge
2.AI1 Down Edge	3.AI2 Up Edge
4.AI2 Down Edge	5.AI3 Up Edge
6.AI3 Down Edge	7.AI4 Up Edge

Menu 8 1

Flow Batch Controller

The internal batch controller in the flowmeter is able to control the input signals through keypad or analog input Serial Port. Output signals can be transmitted through OCT or relay.

The flow batch value can be modified in this window.

The screen will enter the batch control display as soon as the modification completed.

FlowBatch Controller
1000 x1 m3

Menu 8 2

Date Totalizer

The following options are available:

- 0. Day
- 1. Month
- 2. Year

In this window, it is possible to review the historical flow data totalizer for any day for the last 64 days, any month for last 64 months and any year for last 5 years.

Press **ENT**, use the **▲/+** or **▼/-** to review totalizer in days, months and years. Left upper corner: "00-63" indicates the serial numbers;

In the middle: "03-04-05" indicates the date; Upper right corner: "G-H-I" indicates the working condition. If there is only "-----" displayed, it indicates the system was normal during that time period. If other characters displayed, please refer to the "Error Code and Resolutions".

For example, to display the flow total for July 18, 2000, the display "-----" at the upper right corner of the screen indicates that it was working properly the whole day. On the contrary, if "G" is displayed, it indicates that the instrument gain was adjusted at least once. Probably it was offline once on that day. If "H" is displayed, it indicates that poor signal was detected at least once. Also, it indicates that the operation was interrupted or problems occurred in the installation.

Date Totalizer [82
0. Day

00 03-04-05 G-H-I
- 0 m3

Menu 8 3

Automatic Flow Correction

With the function of automatic flow correction, the flow lost in an offline session can be estimated and automatically adjusted. The estimate is based on the average value, which is obtained from flow rate before going offline and flow measured after going online the next time, multiplied times the time period that the meter was offline. Select "NO" to cancel this function.

Automatic Correction
YES

00 03-04-05 -----
>4356.78 m3

Menu 8 4

Energy Units Select

Select Energy Units: Giga Joule (GJ) and Kilocalories.
The factory default unit is GJ.

The following options are available:

- 0. Giga Joule (GJ)
- 1. Kilocalorie (Kc)
- 2. MBtu
- 3. KJ
- 4. Btu

Energy Units Select
0. Giga Joule (GJ)

Menu 8 5

Temperature Select

Select temperature signal source of calorimetry:

- 0. Input from AI1, AI2
- 1. Fixed Difference in temperature

“0. From AI1, AI2” represent using AI1, AI2 analog input channel to input temperature signal. AI1, AI2 analog input must be 4~20mA or 0~20mA current signal sent from the temperature sensor.

“1. Fixed Difference” represents difference in temperature and is a fixed value entered by keypad. Enter fixed difference in temperature value after selected this item.

temperature and is a fixed value entered by keypad. Enter fixed difference in temperature value after selected this item.

Temperature Select
0. From AI 1,AI 2

Menu 8 6

Specific Heat Select

Select the following 2 kinds of specific heat value:

- 0. Standard Specific Heat
- 1. Fixed Specific Heat

Generally specific heat water is 0.0041868GJ/M3°C

Specific Heat Select
0. Standard

Menu 8 7

Energy Totalizer Switch

Select “ON” represent to open Energy Totalizer

Select “OFF” represent to close Energy Totalizer

Energy Totalizer
ON

Menu 8 8

Energy Multiplier

Select Energy Multiplier range: 10^{-4} ~ 10^6 (E-4~E6)

Energy Multiplier [88
4. x1 (EO)

Menu 8 9

Reset Energy Totalizer

Select “YES” to reset Energy Totalizer value.

Reset Energy Total
NO

Menu 9 0

Signal Strength and Signal Quality

Display the measured signal strength and signal quality Q value upstream and downstream.

Signal strength is indicated from 00.0 ~ 99.9. A reading of 00.0 indicates no signal detected, while 99.9 indicates maximum signal strength. Normally the signal strength should be ≥ 60.0 . Signal quality Q is indicated by 00~99. Therefore, 00 indicates the poorest signal while 99 indicates the best signal. Normally, signal quality Q value should be better than 50.

Strength+Quality [90
UP:00.0 DN:00.0 Q=00

Menu 9 1

TOM/TOS*100

Display the ratio between the actual measured transmit time and the calculated transmit time according to customer's requirement. Normally the ratio should be $100 \pm 3\%$. If the difference is too large, the user should check that the parameters are entered correctly, especially the sound velocity of the fluid and the installation of the transducers. This data is of no use before the system is ready.

TOM/TOS * 100 [91
0.0000%

Menu 9 2

Fluid Sound Velocity

Display the measured fluid sound velocity. Normally this value should be approximately equal to the entered value in Window M21. If the difference is too large, it probably results from an incorrect value entered in Window M21 or improper installation of the transducers.

Fluid Sound Velocity
1443.4 m/s

Menu 9 3

Total Time and Delta Time

Display the measured ultrasonic average time (unit: nS) and delta time of the upstream and downstream (unit: nS) time. The velocity calculation in the flowmeter is based on the two readings. The delta time is the best indication that the instrument is running steadily. Normally the fluctuation in the ratio of the delta time should be lower than 20%. If it is not, it is necessary to check if the transducers are installed properly or if the parameters have been entered correctly.

Totl Time, Delta Time
8.9149uS, -171.09nS

Menu 9 4

Reynolds Number and Factor

Display the Reynolds number that is calculated by the Flowmeter and the factor that is set currently by the flowmeter. Normally this scaling factor is the average of the line and surface velocity factor inside the pipe.

Reynolds Number [94
0.0000 1.0000

Menu 9 5

Data Interval

Input the data collection time interval in this menu. Time is in seconds. The interval can be selected in the range of 5~13000 seconds (3.6 hours). Press ENT, the display shows ">" on the second line, input the required data collection interval, and then press

ENT. The data collection interval is set. The factory default is 5 seconds.

DATA interval [95
300 S

Menu /+ 0

Power ON/OFF Time

To view the power on/off time and flow rate for the last 64 update times to obtain the offline time period and the corresponding flow rate. Enter the window, press ENT to display the last update before the last 64 times of on/off time and flow rate values. "ON" on right hand indicates that time power is on; "00" on the upper left corner indicates "00-07-18 12:40:12" the date time; flow rate is displayed in the lower right corner.

ON/OFF Time [+0
Press ENT When Ready

00-07 18 12:40:12
*ON 123.65 m3/h

Menu /+ 1

Total Working Hours

With this function, it is possible to view the total working hours since the flowmeter left the factory. The figure on the right indicates that the total working hours since the flowmeter left the factory is 1107 hours 1 minutes 41 seconds.

Total Work Hours [+1
00001107:01:41

Menu /+ 2

Last Power Off Time

Display the last power off time.

Last Power Off Time
03-04-04 11:33:02

Menu /+ 3

Last Flow Rate

Displays the last flow rate.

Last Flow Rate [+3
100.43 m3/h

Menu /+ 4

Total ON/OFF Times

Display total on/off times since the flowmeter left the factory.

ON/OFF Times [+4
40











Menu /+ 5

Calculator

This window works as a calculator with an internal

Calculator : Input X=
0

calculation function. To use the calculator, enter the first parameter X, select a calculating operator; if there is a second parameter, enter it as parameter Y, then combine the calculation results into parameter X. For example:

To calculate 1+2, then it is necessary to press     , use  or  to select “+”, press    to confirm. This calculator is also provided with a register function. To select it, use the same as used with calculators.

Note: Using the calculator while the system is running will not influence the measurement.

7. Error Diagnoses

The ultrasonic flowmeter has advanced self-diagnostics functions and displays any errors in the upper right corner of the LCD via definite codes in a date/time order. Hardware error diagnostics are usually performed upon each power on. Some errors can be detected during normal operation. Undetectable errors caused by incorrect settings and unsuitable measurement conditions can be displayed accordingly. This function helps to detect the errors and determine causes quickly; thus, problems can be solved in a timely manner according to the solutions listed in the following tables.

Errors displayed in the flowmeter are divided into two categories:

Table 1 is for errors displayed during self-diagnostics upon power on. “* F” may be displayed on the upper left corner of the screen after entering the measuring mode. When this occurs, it is necessary to power on for self-diagnostics once again to detect and solve possible errors using the table below. If a problem still exists, please contact the factory or the factory’s local representative for assistance.

Table 2 applies when errors caused by incorrect settings and signals are detected and are announced by error codes displayed in Window M08.

7.1. Table 1. Self-diagnoses and error solutions (upon power on)

LCD Display	Cause	Solution
Rom Parity Error	System ROM illegal or error	Contact the factory
Stored Data Error	System stored data block error	Power on again or contact the factory
SCPU Fatal Error	SCPU circuit fatal error	Power on again or contact the factory
Timer Slow Error Timer Fast Error	System clock error	Contact the factory
CPU or IRQ Error	CPU or IRQ problem	Power on again
System RAM Error	System RAM questionable	Power on again or contact the factory
Time or Bat Error	System date time chip error	Power on again or contact the factory
No Display, Erratic or Abnormal Operation	Bad wiring connection	Check wiring connections
Stroke Key - No Response	Keypad locked or bad plug connection	Enter the unlock password if the keypad is locked

7.2. Table 2. Error codes and solutions (during operation)

Code	M08 Display	Cause	Solution
*R	System Normal	System normal	No errors
*J	SCPU Fatal Error	Hardware defect	Contact the factory
*I	Signal Not Detected	Signal not detected.	Attach transducer to the pipe and tighten it securely. Apply a plenty of coupling compound on transducer and pipe wall.
		Spacing is not correct between the transducers or not enough coupling compound applied to face of transducers.	Remove any rust, scale, or loose paint from the pipe surface. Clean it with a file.
		Transducers installed improperly.	Check the initial parameter settings.
		Scale is too thick.	Remove the scale or change the scaled pipe section. Normally, it is possible to change a measurement location. The instrument may run properly at a new site with less scale.
		New pipe liner.	Wait until liners solidified and saturated.
*H	Low Signal Strength	Low signal strength. Cause refers to above-mentioned reasons.	Solution refers to above-mentioned solutions.
*H	Poor Signal Quality	Poor signal quality All reasons are included in the above-mentioned causes.	Solution refers to above-mentioned solutions.
*E	Current Loop over 20mA (No influence normally. Ignore it if no current output is being used.)	4-20mA current loop over 120%. Improper settings to current loop output.	Check settings(refer to Window M56)and confirm if actual flow is too high.
*Q	Frequency output over set value No influence normally. Ignore it if no frequency output is being used.	Frequency output over 120%. Improper settings to frequency output or actual flow are too high.	Check settings(refer to Window M66-M69)and confirm if the actual flow is too high.
*F	Refer to Table 1.	Error in self-diagnoses during power on.	Power on again; resolve it by the method listed in Table 1. If it is still a problem, contact the factory.
		Permanent hardware error.	Contact the factory.
*G	Adjusting Gain>S1 Adjusting Gain>S2 Adjusting Gain>S3 Adjusting Gain>S4 (Display in Windows M00,M01,M02,M03)	Adjusting gain for normal measurement. Stop in S1 or S2 and only switch between S1 and S2 indicates a poor waveform or low signal strength. All reasons may be included in above-mentioned items.	
*K	Pipe Empty. Set in Window M29	No fluid in pipe or settings incorrect.	Once fluid is detected in the pipe, set 0 in Window M29.

7.3. Frequently Asked Questions and Answers

Question: New pipe, high quality material, and all installation requirements met: why still no signal detected?

Answer: Check pipe parameter settings, installation method and wiring connections. Confirm if the coupling compound is applied adequately, the pipe is full of liquid, transducer spacing agrees with the screen readings and the transducers are installed in the right direction.

Question: Old pipe with heavy scale inside, no signal or poor signal detected: how can it be resolved?

Answer: Check if the pipe is full of fluid. Try the Z method for transducer installation (If the pipe is too close to a wall, or it is necessary to install the transducers on a vertical or inclined pipe with flow upwards instead of on a horizontal pipe).

Carefully select a good pipe section and fully clean it, apply a wide band of coupling compound on each transducer face (bottom) and install the transducer properly.

Slowly and slightly move each transducer with respect to each other around the installation point until the maximum signal is detected. Be careful that the new installation location is free of scale inside the pipe and that the pipe is concentric (not distorted) so that the sound waves do not bounce outside of the proposed area.

For pipe with thick scale inside or outside, try to clean the scale off, if it is accessible from the inside. (Note: Sometimes this method might not work and sound wave transmission is not possible because of the a layer of scale between the transducers and pipe inside wall).

Question: Why is there no CL (current loop) output?

Answer: Check if the desired current output mode is set in Window M55. See if the CL is powered off by “CL Off” settings.

Open the electronics enclosure to inspect the hardware circuit. Check to see if the short-circuit terminal near terminal 3 is in place between 1-2, i.e. Direct Output Mode(at location 2-3, set CL output as Transmitter Mode with external power supply).

Question: Why is the CL output abnormal?

Answer: Check to see if the desired current output mode is set in Window M55.

Check to see if the maximum and minimum current values are set properly in Windows M56 and M57. Re-calibrate CL and verify it in Window M49.

Question: Why is the flow rate still displayed as zero while there is fluid obviously inside the pipe and a symbol of “R” displayed on the screen?

Answer: Check to see if “Set Zero” was carried out with fluid flowing inside the pipe(Refer to Window M42). If it is confirmed, recover the factory default in Window M43.

Question: With a poor measurement site environment in the plant and the voltage and power supplies fluctuating widely, is the instrument really able to keep running 24 hours a day repeatedly without stopping and last for several years under such conditions?

Answer: Flowmeter is designed to work with high reliability under such conditions. It is provided with an intelligent signal conditioning circuit and internal correction circuitry. It will work under strong interference conditions and is able to adjust itself with strong or weak sound waves. It will work in a wide band of voltage: 90-245VAC or 10V~36VDC voltage.

8. Product Overview

8.1. Introduction

The SL1188 is a state-of-the-art universal transit-time flowmeter designed using SLSI technology and low voltage broadband pulse transmission. While principally designed for clean liquid applications, the instrument is tolerant of liquids with small amounts of air bubbles or suspended solids found in most industrial environments.

8.2. Features of SL1188

With distinctive features such as high precision, high reliability, high capability and low cost, the flowmeter features other advantages:

Low consumption power, high reliability, anti-jamming and outstanding applicability.

Clear, user-friendly menu selections make flowmeter simple and convenient to use.

U.S., British and Metric measurement units are available. Meanwhile, almost all-universal measurement units worldwide may be selected to meet customer's requirements.

Daily, monthly and yearly totalized flow: Totalized flow for the last 64 days and months as well as for the last 5 years are may be viewed.

Power on/off function: allows the viewing of time and flow rate as power is switched on and off 64 times. Also, the flowmeter has manual or automatic amendment during offline sessions.

Self-contained signal output, including relay, open collector, frequency and 4~20mA current loop analog outputs, etc.

Parallel operation of positive, negative and net flow totalizes with scale factor (span) and 7 digit display, while the output of totalize pulse and frequency output are transmitted via relay and open collector.

Internally configured batch controller makes batch control convenient.

8.3. Theory of Operation

When the ultrasonic signal is transmitted through the flowing liquid, there will be a difference between the upstream and downstream transit time (travel time or time of flight), which is proportional to flow velocity, according to the formula below.

$$V = \frac{MD}{\sin 2\theta} \times \frac{\Delta T}{T_{up} \cdot T_{down}}$$

$$\Delta T = T_{up} - T_{down}$$

Remarks:

V Medium Velocity

M Ultrasonic frequency of reflection

D Pipe Diameter

θ The angle between the ultrasonic signal and the flow

T_{up} Transit time in the forward direction

T_{down} Transit time in the reverse direction

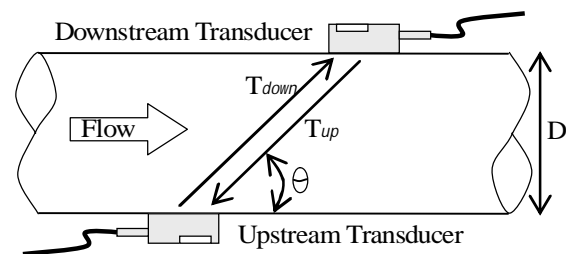

8.4. Applications

Water, sewage (with low particle content) and seawater

Water supply and drainage water

Power plants (nuclear power plant, thermal and hydropower plants), heat energy, boiler feed water and energy management system

Metallurgy and mining applications (cooling water and acid recovery, for example)

Petroleum and chemicals

Food, beverage and pharmaceutical

Marine operation and maintenance

Energy economy supervision and water conservation management

Pulp and paper

Pipeline leak detection

Regular inspection, tracking and collection

Energy measuring and balance

Network monitoring systems and energy/flow computer management

8.5. Specifications

Performance specifications	
Flow range	0~±40 ft/s (0~±12 m/s)
Accuracy	±1.0% of measured value (for 1.5~40 ft/s or -1.5~-40 ft/s)
Repeatability	0.3%
Linearity	±1.0%
Pipe size	1 in to 200 in (25mm to 5000mm)
Function specifications	
Outputs	Analog output: 0/4~20mA (max load 750Ω) Pulse output: 0~9999Hz, OCT, (min. and max. frequency is adjustable) Relay output: SPST, max 1Hz, (1A@125VAC or 2A@30VDC)
Communication	RS232
SD Card	Capability: 1GB Max record: 512days Record time interval: 5~13000s
Power supply	90 to 245 VAC, 48 to 63Hz. Or 10 to 36 VDC
Keypad	16 (4×4) key with tactile action
Display	40 character, 2 line (20×2) lattice alphanumeric, backlit LCD
Temperature	Transmitter: -40°C ~ 60°C Transducer: -40°C ~ 80°C (standard)
Humidity	Up to 99% RH, non-condensing
Physical specifications	
Transmitter	NEMA 4X (IP65), Die-cast aluminum
Transducer	Encapsulated design double-shielded transducer cable Standard/maximum cable length: 30ft/1000ft (9m/305m)
Weight	Transmitter: approximately 4.7 lb (2.15kg) Transducer: approximately 2.0 lb (0.9kg) (standard)

9. Appendix 1 - Flow Application Data

9.1. Sound Velocity and Viscosity for Fluids Commonly Used

Fluid	Sound Velocity (m/s)	Viscosity
water 20°C	1482	1.0
water 50°C	1543	0.55
water 75°C	1554	0.39
water 100°C	1543	0.29
water 125°C	1511	0.25
water 150°C	1466	0.21
water 175°C	1401	0.18
water 200°C	1333	0.15
water 225°C	1249	0.14
water 250°C	1156	0.12
Acetone	1190	
Carbine	1121	

Ethanol	1168	
Alcohol	1440	1.5
Glycol	1620	
Glycerin	1923	1180
Gasoline	1250	0.80
Benzene	1330	
Toluene	1170	0.69
Kerosene	1420	2.3
Petroleum	1290	
Retinal	1280	
Aviation kerosene	1298	
Peanut oil	1472	
Castor oil	1502	

9.2. Sound Velocity for Various Materials Commonly Used

Pipe Material	Sound Velocity (m/s)
Steel	3206
ABS	2286
Aluminum	3048
Brass	2270
Cast iron	2460
Bronze	2270
Fiber glass-epoxy	3430
Glass	3276
Polyethylene	1950

PVC	2540
Titanium	3150
Cement	4190
Bitumen	2540
Porcelain enamel	2540
Glass	5970
Plastic	2280
Polyethylene	1600
PTFE	1450
Rubber	1600

9.3. Sound Velocity in Water (1 atm) at different temperatures

t(°C)	v(m/s)
0	1402.3
1	1407.3
2	1412.2
3	1416.9
4	1421.6
5	1426.1
6	1430.5
7	1434.8
8	1439.1
9	1443.2
10	1447.2
11	1451.1
12	1454.9
13	1458.7
14	1462.3
15	1465.8
16	1469.3
17	1472.7
18	1476.0
19	1479.1
20	1482.3
21	1485.3
22	1488.2
23	1491.1
24	1493.9
25	1496.6
26	1499.2
27	1501.8
28	1504.3
29	1506.7
30	1509.0
31	1511.3
32	1513.5
33	1515.7

34	1517.7
35	1519.7
36	1521.7
37	1523.5
38	1525.3
39	1527.1
40	1528.8
41	1530.4
42	1532.0
43	1533.5
44	1534.9
45	1536.3
46	1537.7
47	1538.9
48	1540.2
49	1541.3
50	1542.5
51	1543.5
52	1544.6
53	1545.5
54	1546.4
55	1547.3
56	1548.1
57	1548.9
58	1549.6
59	1550.3
60	1550.9
61	1551.5
62	1552.0
63	1552.5
64	1553.0
65	1553.4
66	1553.7
67	1554.0
68	1554.3

69	1554.5
70	1554.7
71	1554.9
72	1555.0
73	1555.0
74	1555.1
75	1555.1
76	1555.0
77	1554.9
78	1554.8
79	1554.6
80	1554.4
81	1554.2
82	1553.9
83	1553.6
84	1553.2
85	1552.8
86	1552.4
87	1552.0
88	1551.5
89	1551.0
90	1550.4
91	1549.8
92	1549.2
93	1548.5
94	1547.5
95	1547.1
96	1546.3
97	1545.6
98	1544.7
99	1543.9

Refer to the sound velocity of other fluids and materials, please contact the factory.

10. Appendix2 - Calorimeter

10.1. Calorimeter Function

The flowmeter has a calorimeter function. The meter can calculate automatically caloric content of water under various temperatures, and obtain instantaneous caloric value and totalized caloric value. A separate customer-provided Temperature signal input is sent to the meter via the AI1, AI2 terminals, which can be configured for a 4~20mA or 0~20mA current signal.

10.2. Wiring

AI1, AI2 are connected with 2 temperature sensors by connection cable. The 2 temperature sensors are installed on the flow pipe and return pipe, they can input 4-20mA signals to AI1, AI2 of the transmitter (see wiring connection).

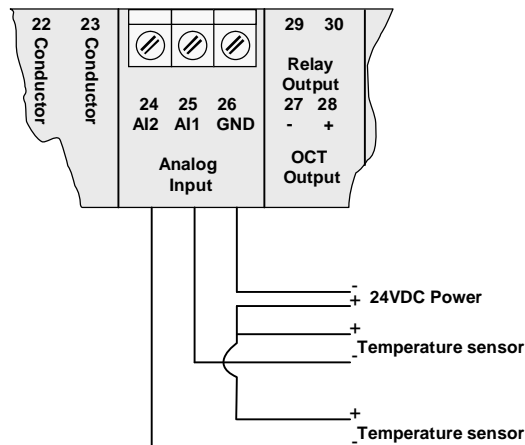

10.3. Calorimetry Method

The flowmeter has 2 calculation methods to achieve calorimetry:

Formula 1: Energy (caloric quantity) = Flow Value × Difference in Temperature × Specific Heat

Note:

Select Energy units in window M84

Difference in Temperature: Difference in 2 analog input AI1, AI2 (transmitted from 2 temperature sensors)

Specific Heat: Input specific heat value in window M86, generally select Fixed Specific Heat value 0.0041868GJ/M3 for Water

Formula 2: Energy (caloric quantity) = Flow Value × Difference in Energy AI1 and Energy AI2

Energy (Instantaneous Caloric/Totalized Caloric) can be calculated automatically and display in window M05.

If the difference in Temperature is a fixed value, the meter can calculate Energy directly without temperature sensors. Enter Fixed Difference in Temperature value in window M85.

For example, we know Fixed Difference is 10°C, press **Menu** **8** **5**, **ENT** **7/-** to select “ 1. Fixed Difference”, enter **1** **0**. Energy can be calculated automatically and display in window M05.

10.4. Set Temperature Value Range

Input temperature signal via AI1, AI2 terminals, set its measurement range in window M63 and window M64.

For example, the inlet temperature sensor outputs a 4-20mA current signal to the meter, and this is set to represent a temperature range of 10°C to 50°C. Connect this sensor to the AI1 terminal, enter 10, 150 in window M63. Current mA value and temperature value of AI1 will display in window M06. The same procedure is then followed for the outlet temperature sensor; the zero and span for this sensor is entered into window M64

Related calorimeter window as follows:

Window M05: Display energy and totalized energy

Window M06: Display AI1, AI2 current value and the corresponding temperature value

Window M63: Enter temperature value which AI1 4mA and 20mA analog input represent

Window M64: Enter temperature value which AI2 4mA and 20mA analog input represent

Window M85: Select energy units

Window M86: Select temperature source

Window M87: Specific heat value

Window M88: Select energy multiplier

Window M89: Reset energy totalizer

11. Appendix3 - Wetted Transducer

11.1. Overview

Insertion transducers can be installed into metal pipelines via an isolation ball valve (installation into pipelines of plastic or other materials may require an optional coupling). The maximum pipe diameter in which insertion transducers can be installed is DN5000mm. Sensor cable length (9m standard) normally can be extended to as long as 305m. Follow the procedure below to install insertion transducers (If hot tapping is required, refer to the operating instructions of the manufacturer of hot tapping devices. Note that the pipe tap size should not be smaller than $\phi 38\text{mm}$).

Figure 1 shows a diagram of the Insertion Transducer (Ordering option – W). The insertion transducer is attached to its mounting base (which is welded to the pipe section at the measurement point) via a ball valve. When the transducer is removed, pipe fluids can be contained by shutting off the ball valve. Therefore, installation and extraction of the transducer can be performed without relieving pipeline pressure. An O-ring seal and joint nut guarantee user safety while installing or operating the transducer.

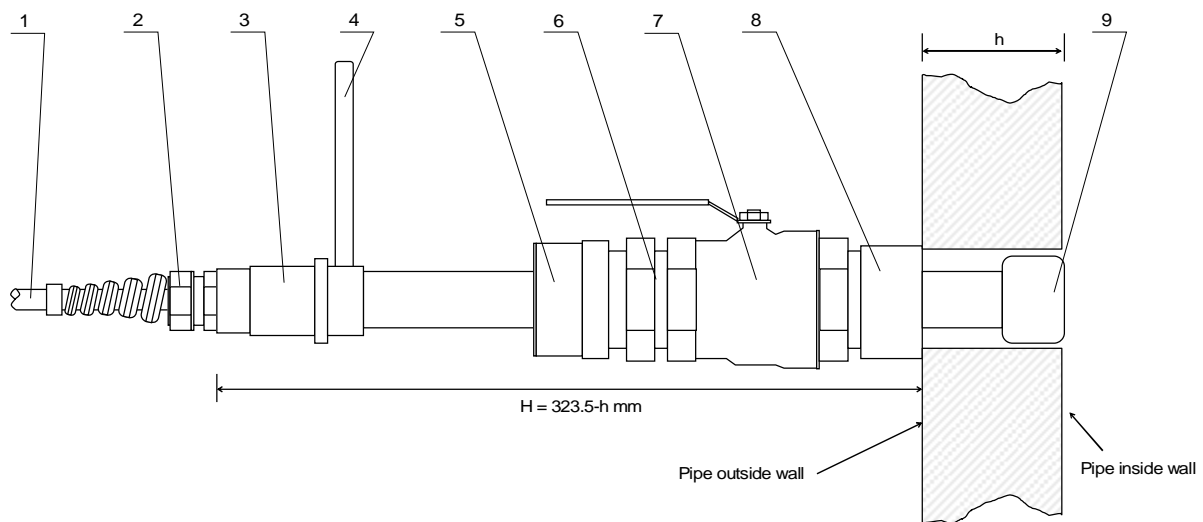

- | | |
|-------------------------------------|-----------------------|
| 1. Cable | 6. Joint nut |
| 2. Flexed-resistance revolved piece | 7. Ball valve |
| 3. Connector | 8. Mounting base |
| 4. Orientation handle | 9. Transducer housing |
| 5. Locating sleeve | |

Fig.1 Construction Drawing of W type Transducer

11.2. Measurement Point Selection

To guarantee highly accurate measurement results, it is necessary to select an appropriate measurement point before installing the transducer. For examples of measuring point selection, see the related section in the manual.

11.3. Determining Transducer Spacing & Transducer Installation

To obtain the strongest signal strength and the most accurate measurement results, it is critical to ensure correct transducer spacing. Select an appropriate measurement point to install the transducer

Perform the following procedure to adjust the transducer spacing:

Calculate the center-to-center hole distance between the two transducers by using the formula below:

$$S = SP + 34 \text{ (Units in mm)}$$

In this formula, SP is the spacing value calculated (by the flowmeter) by entering the pipe parameters such as pipe inner diameter, pipe wall thickness, etc. (Units in mm).

Drill holes 40mm in diameter at the determined measurement points on the pipe and weld the mounting base of the transducer vertically at that position on the pipe surface.

There are two transducer cables for the transducers: Upstream transducer cable with red terminal ends and downstream transducer cable with blue terminal ends. It should be noted that upstream transducer and downstream transducer must be installed at the appropriate measurement point in accordance with the flow direction. If the cable connection is reversed, opposite flow direction will be measured by the flowmeter.

Tighten the ball valve securely onto the mounting base (shut off the ball valve).

Unscrew the locating sleeve and loosen the lock ring, retract the transducer into the joint nut, and then tighten the joint nut onto the ball valve.

Open the ball valve and insert the transducer into the pipe. At the same time, measure the dimension between the outside pipe and the A point (See Figure 1) and make sure it complies with the following formula:

$$H = 323.5 - h$$

In this formula:

H is Mounting height (mm)

323.5 is Transducer length (mm)

h is Pipe wall thickness (mm)

Attach the lock ring to the joint nut by fitting its pinhole in the locating pin, then tighten the screw slightly and turn the orientation handle until it points at the middle position between the two transducers and its axes matches the axes of the pipeline. Finally, tighten the locking screw and screw the locating sleeve onto the joint nut.

Connect the transducer cables to the corresponding upstream/downstream (upstream=red, downstream=blue) terminal ends.



Important

For horizontal pipelines, transducers must be fixed on the sides of the pipe (i.e. at the 3 and 9 o'clock position of the pipe) to prevent signal attenuation caused by sediment on the bottom of the pipe or air bubbles and air pockets in the top of the pipe.

11.4. Transducer Mounting Methods

Three transducer-mounting methods are available. Select one of them in the menu according to specific application conditions. They are: Z method, V method, W method

11.4.1. Z Mounting Method

Z method is the most commonly used mounting method for insertion-type ultrasonic flowmeters, suitable for pipe diameters ranging from 50mm to 5000mm. Due to strong signal strength and high measurement accuracy, the Z method is preferable for pipe sections severely rusted or with too much scale formation on the inside wall. When installing the transducer using the Z method, be sure that the two transducers and the pipeline center axis are in the same plane, but never in the 6 or 12 o'clock positions. see below:

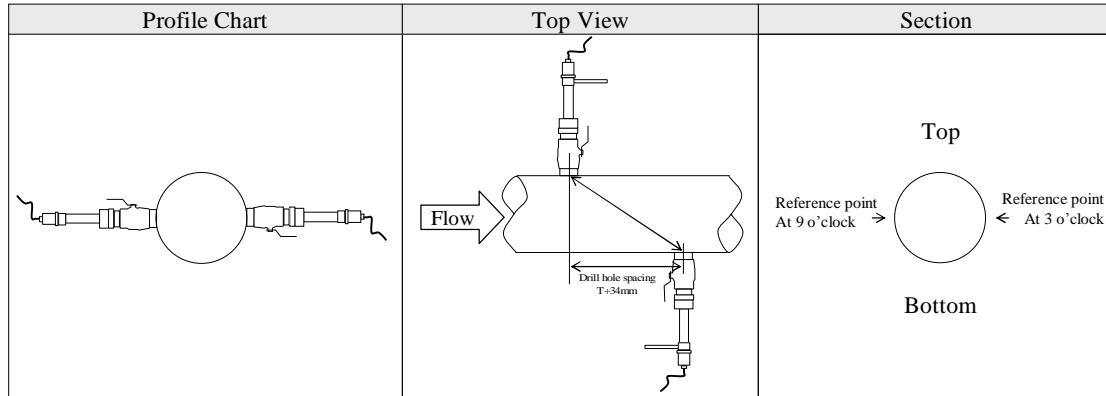

11.4.2. V Mounting Method

V method is suitable for pipe diameters ranging from 300mm to 1200mm. It is used when only one side of the pipe is available (example: the other side is against a wall) at the installation site, see below:

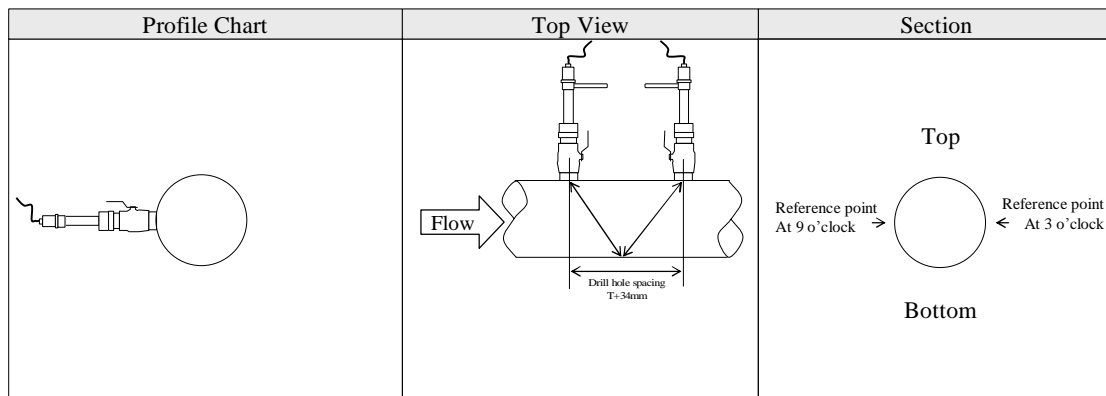

11.4.3. W Mounting Method

W method is suitable for pipe diameters ranging from 150mm to 500mm (see Figure 4). With this method, the acoustical circuit can be extended to enhance the stability of the measurement. see below:

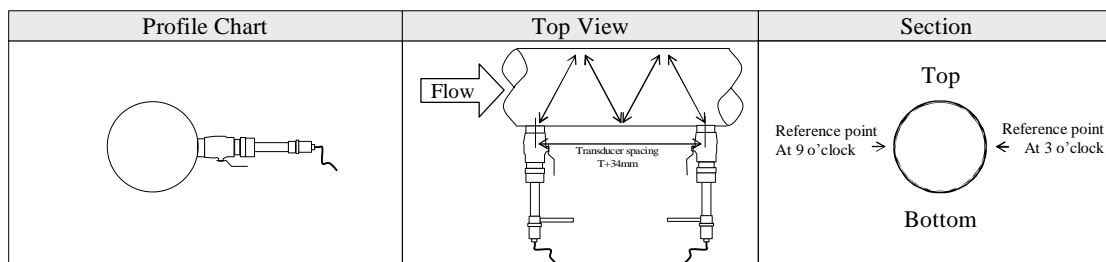

12. Appendix4 - Serial Interface Network Use and Communications Protocol

12.1. Overview

The flowmeter has communication protocol. Its hardware directly supports a modem, a composition of flow data monitoring system that is economical, reliable and based on telephone line transmission. It can also be connected to a RS-485 bus through a RS232-RS485 change-over panel.

Two basic schemes can be chosen for networking, i.e. the analog current output method only using the flowmeter or the RS232 communication method via serial port directly using the flowmeter. The former is suitable to replace dated instruments in old monitoring networks. The later is used in new monitoring network systems. It has advantages such as low hardware investment and reliable system operation.

When the serial port communication method is directly used to implement a monitoring network system, the address identification code (in window M46) of the flowmeter is used as network address code. Expanded command set with [W] is used as communication protocol. Thus analog current loop and OCT output of flowmeter can be used to control the opening of a control valve. The relay output can be used to power-on/off other equipment. The analog input of the system can be used to input signals such as pressure and temperature. The system provides an RTU function for flow measurement.

RS-232(0~15m) or RS-485(0~1000m) can be directly used for data transmission link for a short distance. Current loop, radio transmission and modem can be used in medium or long distance transmission.

When the flowmeter is used in a network environment, various operations can be performed at the host device, except for programming of the address identification code, which needs to be done at the flowmeter keyboard.

The command answer mode is used in data transmission, i.e. the host device issues commands and the flowmeter answers correspondingly.

Common/special flow/thermal data monitoring system developed by our company can be used for flow data collection. Based on characteristics of the flowmeter, the system makes full use of software and hardware designs with flowmeter features. The system is simple, clear, low cost, and reliable in operation.

12.2. Serial port definitions

Flowmeter:

- PIN 1 empty
- PIN 2 TXD receive
- PIN 3 DXD send
- PIN 4 DTS
- PIN 5 ground
- PIN 6 DSR
- PIN 7 +5V
- PIN 8 empty
- PIN 9 RING signal input

PC:

- PIN 1 empty
- PIN 2 DXD receive
- PIN 3 TXD send
- PIN 5 ground

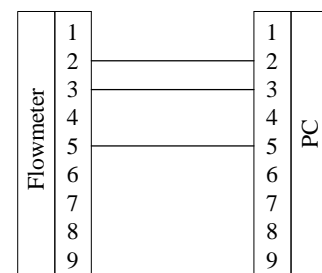

Figure 12-1 Flowmeter serial port definitions

12.3. Direct connection via RS232 to the host device

See the above Figure 12-1

12.4. Communication protocol and the use

The communication protocol format used by the ultrasonic flowmeter is an expanded set of the Fuji FLV series flowmeter protocol. The host device requests the flowmeter to answer by sending a “command”. The baud rate of asynchronous communication (Primary station: computer system; Secondary station: ultrasonic flowmeter) is generally 9600bit/s. A single byte data format (10 bits): one start bit, one stop bit and 8 data bits. Check bit: none.

12.4.1. Basic commands

A data character string is used to express basic commands and a carriage return character is used to express the end of the command. The characteristic is that the length of data is flexible. Frequently used commands are as follows:

Table 12-1 Communication commands

Command	Description	Data format
DQD(cr) *0	Return daily instantaneous flow	±d.ddddddE±dd(cr) *1
DQH(cr)	Return hourly instantaneous flow	±d.ddddddE±dd(cr)
DQM(cr)	Return instantaneous flow per minute	±d.ddddddE±dd(cr)
DQS(cr)	Return instantaneous flow per second	±d.ddddddE±dd(cr)
DV(cr)	Return instantaneous velocity	±d.ddddddE±dd(cr)
DI+(cr)	Return positive accumulative flow	±dddddddE±d(cr) *2
DI-(cr)	Return negative accumulative flow	±dddddddE±d(cr)
DIN(cr)	Return net increment	±dddddddE±d(cr)
DID(cr)	Return identification code of instrument (address code)	dddd(cr) 5 bits in length
DL(cr)	Return signal intensity	UP:dd.d, DN:dd.d, Q=dd(cr)
DS(cr)	Return percentage of analogous output (AO)	±d.ddddddE±dd(cr)
DC(cr)	Return current error code	*3
DA(cr)	Alarm signal of OCT or RELAY	TR:s, RL:s(cr) *4
DT(cr)	Current date and time	yy-mm-dd, hh:mm:ss(cr)
M@(cr)	Analogous key value @ sent to flowmeter	M@(cr) *5
LCD(cr)	Return currently displayed content on LCD display	
C1(cr)	OCT actuated	
C0(cr)	OCT not actuated	
R1(cr)	RELAY actuated	
R0(cr)	RELAY not actuated	
FOddd(cr)	Frequency output value n	Fddd(cr)(lf)
Aoa(cr)	Current output value a of current loop	AOa(cr)(lf) *6
ESN(cr)	Return electronic serial number	ddddddt(cr)(lf) *7
N	Networking command prefix of a single byte address	*8
W	Networking command prefix of numeric string address	*8
P	Prefix of return command with check	
&	Function sign of command ”add”	
RING(cr)(lf)	Modem request handshake command	ATA(CR)(lf)
OK(cr)	Modem answer signal	No output
	Flowmeter request handshake signal	AT(CR)(LF)

Note:

- (cr)expresses carriage return. Its ASCII value is 0DH. (lf) expresses line feed. Its ASCII value is 0AH.
- “d” expresses 0-9 number. 0 value is expressed as +0.000000E+00.
- “d” expresses 0-9 numbers. There is no decimal point in integral part before “E”.
- The status of the machine is expressed by 1-6 letters. See the section of error code for the meaning of the characters. For example, “R” and “IH”.

4. “s” expresses ON or OFF or UD. For example, “TR:ON, RL:ON” expresses that OCT and relay are in an actuated status; “TR:UD, RL:UD” expresses that OCT and relay are not actuated.
5. “@” expresses key value. For example, 30H expresses “0” key; Command “M4” is equivalent to pressing the key “4”.
6. “a” expresses current value. The value range is 0-20. For example, AO2.34567 and AO0.2.
7. Eight “ddddddd” express electronic serial number of the machine. “t” expresses the type of the machine.
8. If there are multiple flowmeters in a data network then the basic commands cannot be used alone. The prefix N or W must be added. Otherwise, multiple flowmeters will answer simultaneously, which will causes chaos in the system.

12.4.2. Function prefix and function sign

Prefix P

The character P could add before every basic command. That means the transferred data has CRC verify. The method of counting the verified sum is gained by binary system addition.

For example: Command DI+(CR) (the relative binary system data is 44H, 49H, 2BH, 0DH) transferred data is +1234567E+0m3. (CR) (the relative binary system data is 2BH, 31H, 32H, 33H, 34H, 35H, 36H, 37H, 45H, 2BH, 30H, 6DH, 33H, 20H, 0DH, 0AH). And command PDI+ (CR) transferred data is +1234567E+0m3! F7 (CR), “!” means the character before it is the sum character, and the verified sun of the two bytes after it is (2BH+31H+32H+33H+34H+35H+ 36H+37H+45H+2BH+30H+6DH+33H+20H =(2)F7H)

Note: there could be no data before “!”, and also may being blank character.

Prefix W

Usage of prefix W: W+ numeric string address code +basic command. Value range of the numeric string is 0~65535, except 13 (0DH carriage return), 10 (0AH line feed), 42 (2AH *) and 38 (26H &). If the instantaneous velocity of No. 12345 flowmeter is to be accessed, the command W12345DV(CR) can use issued. Corresponding binary code is 57H, 31H, 32H, 33H, 34H, 3 5H, 44H, 56H and 0DH

Function sign &

Function sign & can add up to 5 basic commands (Prefix P is allowed) together to form a compound command sent to the flowmeter together. The flowmeter will answer simultaneously. For example, if No. 4321 flowmeter is requested to simultaneously return: 1] instantaneous flow, 2] instantaneous velocity, 3] positive accumulative flow, 4] thermal accumulative quantity, 5] aI1 analogous input current value and 6] AI2 analogous input current value with check, the following command is issued:

W4321PDQD&PDV&PDI+&PDIE&PBA1&PAI2(CR)

Simultaneously returned data are likely as follows:

+0.000000E+00m3/d!AC(CR)

+0.000000E+00m/s!88(CR)

+1234567E+0m3 !F7(CR)

+0.000000E+0GJ!DA(CR)

+7.838879E+00mA!59(CR)

12.5. Key Code

In a network environment, a key code is used to simulate the use of keys at the host device.

For example, the instruction “M1” is input through the serial port, which is equivalent to pressing Key 1 on the keyboard of the ultrasonic flowmeter. Thus all functions of key operation can be completely implemented at the host device. All key codes are shown in Table 12-2.

Table 12-2 Key Codes

Key	Code of key (Hexadecimal system)	Code of key (Decimal system)	ASCII
0	30H	48	0
1	31H	49	1
2	32H	50	2
3	33H	51	3
4	34H	52	4
5	35H	53	5
6	36H	54	6
7	37H	55	7
8	38H	56	8
9	39H	57	9
.	3AH	58	:
◀	3BH (0BH)	59	;
Menu	3CH (0CH)	60	<
ENT	3DH (0DH)	61	=
▲/+	3EH	62	>
▼/-	3FH	63	?